



RoHS



NINGBO PINYI OUTDOOR TECHNOLOGY CO.LTD.



Acoca

YUEHIKE

NINGBO PINYI OUTDOOR TECHNOLOGY CO.LTD.

- Office : Room 2605,Global Center,No.295,Qixiang North Road,Toayuan Street,Ninghai Town,Ningbo,Zhejiang,CN 315600
- Factory: No.25,Jinshan Rd,Taoyuan Str.Ninghai,Ningbo,China 315600
- Phone +86-574-83533909
- Fax : +86-574-83533907
- E-mail: info@nbpinyi.com

- Facebook /yuetoroutdoor/
- Twitter /yuetor
- instagram /yuetor_outdoor/
- Linkedin /martin-hwa-4a95b3a6/

<http://nbpinyi.en.alibaba.com>
www.nbpinyi.com

CAMPING COLLECTION 2019-2020

BRIEF

Ningbo Pinyi Outdoor Technology Co. Ltd,(N-POT)which was established in 2007, is one of the most professional manufacturers of outdoor products in China. We specialize in products R&D,Im & Ex trading, OEM and ODM business.Your logos and designs are welcomed.

NPOT is a mature company with advanced management system, and it has import and export license. As one of the most successful companies of outdoor products in China, NPOT always leads the innovation in technology material,technique and management.

NPOT, with its registered brand “Yuetor Outdoor “, has its own factory of Outdoor Camping Table & Chair products. In order to meet different requirements from our customers, we have developed and cooperated with many suitable manufacturers in China. Such as the manufacturers of Trekking Pole,Camping Tent,Outdoor Hammock,Outdoor Furniture,Outdoor Camping Kitchen,Outdoor Camping Lighting,BBQ Pro,camping accessories etc. Our customers are from all over the world, mainly from North America,Western Europe,-Japan,Korea and Australia. We have won their trust by our efforts on product quality improvements, on time shipment, professional and considerate service.





**YUETOR OUTDOOR
ENJOY
YOUR JOURNEY**

▼ CONTENTS

05-14 CAMPING FURNITURE

Camping Table
Camping Chair
Camping Stool

15-18 HAMMOCK

19-22 TREKKING POLE

Aluminum Trekking Pole
Carbon Trekking Pole

23-26 CAMPING SLEEPING

Camping Pad
Camping Pillow

27-30 CAMPING TENT

Camping Tent
Beach Tent

31-34 TENT STAKE

35-44 OUTDOOR KITCHEN

Outdoor Cookware Set
Camping Tableware
Kitchen Accessories
Camping Stove



YYZ10

YYZ10 Material : 7075 Aluminum
+600Doxford Fabric
Size:60x40x37cm
Pack Size : 42x17x8cm
Weight : 0.85kg
Max Load : 15kg



CARRYBAG TABLETOP FRAME



Take poles out from the pole cover



Fold the poles by nylon wire



600D Oxford Cloth

Sturdy Pole Pocket

Strengthened Plastic Connector

7075 Aerospace Duralumin

Non-slip Rubber Tip



Material : aluminum
Max Load : 23kg
Pack Includes :
Aluminum Table| Main Frame| Carrying Bag

YYZ04S Size:
15.6"x13.6"x12.8"(39.5x34.5x32.5cm)
Pack Size :
15.7"x5.5"x2.4"(40x14x6cm)
Weight : 1.0kg

YYZ04M Size :
22"x18"x16"(56x45.5x40.5cm)
Pack Size :
22"x5.9"x2.4"(56x15x6cm)
Weight : 1.5kg

YYZ04L Size :
27"x18"x16"(68.5x45.5x40.5cm)
Pack Size :
27.6"x5.9"x2.8"(70x15x7cm)
Weight : 1.8kg



YYZ04S

YYZ04M

YYZ04L



Aluminum Table Top



Package



Reinforced Hinged Design



Anti-Slip Leg Caps



YYZ01S

YYZ01M

YYZ01L



YYZ03S

YYZ03M

YYZ03L



YYZ02

YYZ09



YYZ05S

YYZ05L

Material : 6063aluminum
600doxford Fabric

YYZ01S Size : 57x43x39cm
Pack Size : 22.8"x2.8"(58x7cm)
Weight : 0.752kg
Max Load : 10kg

YYZ01M Size:68x58x40cm
Pack Size : 27.6"x3"(70x7.5cm)
Weight : 0.9kg
Max Load : 15kg

YYZ01L Size:75.5x56x53cm
Pack Size : 31.5"x3"(80x7.5cm)
Weight : 1.0kg
Max Load : 15kg

YYZ02 Material: 6061 Aluminum+
600D Oxford Fabric
Size: 57x42x38cm
Pack Size: 7x7x57cm
Weight: 0.75kg

Material: 6061,7075 Aluminum+
600D Oxford Fabric,PU coating

YYZ03S Size: 44x32.5x23cm
Pack Size: 45x10x7cm
Weight: 0.5kg
Max Load: 25kg

YYZ03M Size: 60x43x42cm
Pack Size: 62x10x9cm
Weight: 1.15kg
Max Load: 25kg

YYZ03L Size: 81.5x59x56.5cm
Pack Size: 83x13x10cm
Weight: 1.80kg
Max Load: 25kg

YYZ05S Material : aluminum
Size: 45x34.5x21.5cm
Pack Size: 45x5.8x9.7cm
Weight : 1.08kg

YYZ05L Material : Aluminum
Size: 61.5x46x39cm
Pack Size: 61.5x5.8x11.8cm
Weight : 1.75kg

YYZ09 material : 6063 aluminum
Size: 13.8"x10"x4.3"(35x26x11cm)
Pack Size : 15.2"x6.3"(38.5x16cm)
Weight : 0.48kg
Max Load : 15kg

YYZ07 Material : aluminum Alloy
Size:
27.6"x27.6"x27.2"(70x70x69cm)
Pack Size : 12.2"x36.6"(31x93cm)
Weight : 3.25kg
Max Load : 50kg

YYZ08 Material : 6061 Aluminum+iron
Size:
20.5"x20.5"x19.6"(52x52x50cm)
Pack Size :
21.6"x5.5"x4.3"(55x14x11cm)
Weight : 2.5kg

YYZ11 Material : aluminum
Size: 120x60x70/62/55cm
Pack Size : 60x60cm
Weight : 4.9kg

YYZ12 Material : aluminum
Size: 31"x24"x27.6"(80x60x70cm)
Pack Size : 31"x24"x2"(80x60x5cm)
Weight : 3.3kg
Max Load : 20kg

YYZ13S Material : aluminum
Size: 27.6"x27.6"x19.6"(70x70x50cm)
Weight :
Max Load :

YYZ13L Material : aluminum
Size: 27.6"x27.6"x27.6"(70x70x70cm)
Weight :
Max Load :

YYZ14 Material : aluminum
Size: 27.6"x27.6"x27.6"(70x70x70cm)
Pack Size : 8"x8"x27.6"(20x20x70cm)
Weight : 3.6kg
Max Load : 20kg

YYZ15 Material : aluminum
Size: 16"x12"x12"(40x30x30cm)
Pack Size: 16"x12"(40x30cm)
Weight : 1kg

YYZ17 Material : 6063 aluminum
Size: 56x40x36cm
Pack Size: 45x12cm
Weight : 1.6kg



YYZ07

YYZ08



YYZ11

YYZ12



YYZ13S

YYZ13L

YYZ15



YYZ14

YYZ17



YYY22



YYY23



SEAT

FRAME

BAG



Material: 6061 Aluminum+600D Oxford Fabric

YYY22

Size : 58x50x100cm
Pack size : 53x12x13cm
Weight : 1.55kg

YYY23

Size:53x35x67cm
pack size : 37x13x11cm
Weight : 1.05kg



YYY01

Material: 6061aluminum
+600D Oxford Fabric
Size: 28x24x27cm
Pack Size: 35x24cm
Weight: 0.42kg

YYY02

Material:13mmWelded steel pipe
+600D Oxford Fabric
Size: 35x35x58cm
Weight: 1kg

YYY03

Material: Steel+600D Oxford
Cloth
Size: 80x50x85cm
Weight: 2kgs
Max Load: 120kg

YYY04

Size:50x50x80cm
Pack size:
weight:1.6kg
Max load:120kg

YYY05

Size:38"x20"x38"(62x55x60.8cm)
Pack size:
Weight:3.97kg
Max load:120kg

YYY06

Size:38.5"x35"x24.8"(50x50x80cm)
Pack size:
Weight:1.8kg
Max load:120kg

YYY07

Size: 47x57x79cm
Weight:3.1kg
Max Load: 120kg

YYY29

Material: 600Dpvc Oxford cloth
/steel tube
Size:31.5x29x(36+60cm)
/12.4"x11.4"x(14"+23.6")
Weight : 3.3lbs(1.5kg)
Max weight: 300lbs140(kg)

YYY01



YYY02



YYY04



YYY06



YYY29



YYY03



YYY05



YYY07





YYY08 Material: Steel+TEXTILENE Fabric
Size: 177x68x113cm
Pack Size: 95x15x68cm
Max Load: 130kg



YYY10 Size:
22"x23.8"x25.8"(56x60.5x65.5cm)
Pack size:
13.4"x3.9"x3.9"(34x10x10cm)
Weight:0.88kg

YYY11 Size:
22"x23.8"x25.8"(56x60.5x65.5cm)
Pack size:
13.4"x3.9"x3.9"(34x10x10cm)
Weight:0.88kg



YYY12 Size:
26"x20.5"x20.5"(66x52x52cm)
pack size:4.7"x15"(12x38cm)
weight:0.775kg

YYY13 Material: Alluminum alloy +
600D oxford cloth + durable mesh
Pole Material: 7075 Duralumin
Size: 68x40x50cm
Pack size: 44x12cm



YYY26 Size:56 x 50.5 x 35 / 65cm
Weight:0.89kg
Seat material : 600Doxford cloth
Bracket shaft: 7075 aluminum
pipe diameter of 12MM
Bracket foot: 6013 aluminum
Max load : 100kg

YYY15 Material : Aluminium Alloy 7075
+600D oxford cloth+mesh cloth
Size: 84*47*42cm
Pack size: 48x12x12cm
Weight: 1.105kg

YYY16 Size:
17.7"x35.4"x39.3"(45x90x100cm)
Pack size:
16.5"x6.1"x5.2"(42x15.5x13.3cm)
Weight:1.18kg
Max load:160kg

YYY17 Material : Aluminium Alloy 7075
+1000D oxford cloth
Size: 60x87x100cm
Pack size: 48x13x13cm
Weight: 1.60kg

YYY18 Material: 6061,7075,7001
Aluminum+Ployester,
600D Oxford Fabric,PVC coating
Size: 48x46x68cm
Pack Size: 32x11x11cm
Weight: 1.05kg
Max Load: 150kg

YYY19 Material: 6061,7075,7001Aluminum
+Ployester,600D Oxford Fabric
+PU coating
Size: 50x46x68cm
Pack Size: 44x12x8cm
Weight: 1.10kg
Max Load: 150kg

YYY20 Material: 6061,7075,7001Aluminum
+Ployester,600D Oxford Fabric
+PU coating
Size: 54x75x100cm
Pack Size: 50x13x12cm
Weight: 1.45kg
Max Load: 150kg

YYY21 Material: 6061,7075,7001Aluminum
+Ployester,600D Oxford Fabric
+PU coating
Size: 80x75x100cm
Pack Size: 50x16x13cm
Weight: 1.7kg
Max Load: 150kg

YYY24 Seat material: 100% polyamide
Shaft material : HTS 6.5 aluminum
Size : 84x50x58cm
Seat height : 41cm
Weight : 1.14kg
Pack size : 14x12x38cm
Max load : 145kg

YYY25 Size : 56x56x66cm
Pack size : 78x20cm
Pole : 16x0.7mm
Material : 600D Oxford cloth+steel pipe
Size of inner box: 79x21cm
Weight : 3.5kg
Max load : 150kg

YYC01 Material: 300D polyester
+7075 aluminum tube
Open size: 190x70x17cm
Folding size: 38x16x15cm
Weight: 1900g





YYD01L



YYD01M

Material: 6063aluminum +600Doxford fabric

YYD01M Size:
7.5"x7.5"x8.7"(19x19x22cm)
Pack Size:10.6"x3.1"(27x8cm)
Weight: 0.31kg

YYD01L Size:
8.7"x8.7"x10.2"(22x22x26cm)
Pack size:10.6"x3.1"(27x8cm)
Weight: 0.31kg

YYD02 Material: 6061 Aluminum+
600D Oxford Fabric
Size: 26x26x21cm
Pack Size: 8x29cm
Weight: 0.31kg

YYD03 Material : 6061 Aluminium
+600D with PVC coated
+Anodized
size: 27.5*24.5*26cm
pack size: 33.5*6.5(Dial)cm
Weight: 0.27kg

YYD04 Material : 7075 Aluminium
+600D oxford cloth
Size: 45x27x36cm
Weight: 0.5kg

YYD05 Material : Aluminium 7075
+600D oxford cloth
+Anodized
Size: 20x20x33cm
Weight: 0.35kg

YYD06 Material: 6061 Aluminum+
600D Oxford Fabric
Size: 28x20x27.5cm
Pack Size: 33x30x4cm
Weight: 0.31kg

YYD07 Material: Aluminum alloy
Fabric: 210g/m2 mesh and nylon
Size: 25x23x23cm
Pack Size: 26x12x5cm
Weight: 0.29kg

Material: 6061aluminum +600D oxford fabric

YYD08S Size:
7.3"x7.5"x9.4"(18.5x19x24cm)
Pack Size:10.6"x3.1"(27x8cm)
Weight: 250g

YYD08L Size:
9.4"x8.7"x10.2"(24x22x26cm)
Pack Size:
9.8"x4.7"x2"(25x12x5cm)
Weight: 293g

YYD09 Material: Steel+600D
Oxford Fabric
Size: 32x16x31cm
Weight: 0.71kg

Material : 7075aluminum+600d oxford fabric

YYDI0S Size:
12.6"x6.3"x12.2"(32x16x31cm)
Weight: 710g

YYDI0L Size:
11.8"x10.2"x11.8"(30x26x30cm)
Weight: 400kg

YYDI1 Material : Stainless Steel
+600D oxford cloth
Size: 36x29x41cm
Pack Size: 36x49cm
Weight: 1.4kg
Max Load: 150kg

YYDI2 Material : 6061 Aluminum
+600D Oxford Fabric
Size: 18.5x19x24cm
Pack Size: 36x49cm
Weight: 0.25kg

YYDI3 Material : Anodized Aluminum
Size: 12" W x 10" D x 15" H
Pack Size: 36x49cm
Weight: 0.9kg
Max Load: 90kg



YYD08L



YYD08S



YYDI0L



YYDI0S



YYD04



YYD05



YYD09



YYDI1



YYD06



YYD07



YYDI2



YYDI3

DC08G200

Size: 118.1"x78.7"(300x200cm)
Material: 210T Nylon
Color: customizable
Weight: 1050g



Color: Customizable

HAMMOCK →

DC05B

Material: 210T nylon Taffeta
 Color: custom Color
 Weight: 845/995g



Size: 118.1"x78.7" | 108.3"x55.1"



DC01B150

Material: canvas
 Color: custom Color
 Weight:
 Package Included:



Size: 110.2"x59" | Size: 110.2"x39.4" | Size: 110.2"x31.5"

DC06G

Material: 210T Nylon
 Color: custom Color
 Weight: 1150/1300g



size: 118.1"x78.7" size: 102.4"x55.1"

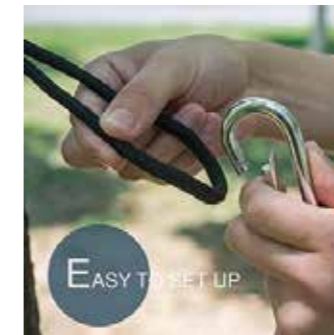

DC07R140

Size: 102.4"x55.1"(260x140cm)
 Material: polyester high strength silk
 Color: custom Color
 Weight: 900g
 Package Included:



DC09G140

Size: 102.4"x55.1"(260x140cm)
 Material: 380T matte silica gel splash proof
 Color: custom Color
 Weight:





TREKKING POLE



Folding Trekking Pole with EVA Foam Handle



TPC13-5

Material: Carbon
Length: 15"-54"(37-135cm)
Diameter: 18/16/14/14/14mm
Handle Grip: EVA+pp
5 Sections
Quick Lock

100% Carbon

Quick Lock Trekking Poles with EVA Handle



TPC11-3

Material: Aluminum 7075
Length: 26"-53"(65-135cm)
Diameter: 18/16/14mm
Handle Grip: EVA
3 Sections
Quick Lock

Material: Carbon



TPC12-3
 Length:26"-53"(65-135cm)
 Diameter:18/16/14mm
 Handle Grip: EVA
 3 Sections
 Quick Lock

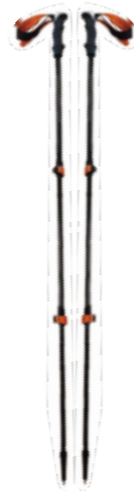

TPC13-3
 Length:26"-53"(65-135cm)
 Diameter:18/16/14mm
 Handle Grip:EVA+pp
 3 Sections
 Quick Lock

Material: 7075Aluminum



TP724-3
 Length:26"-53"(65-135cm)
 Diameter:18/16/14mm
 Handle Grip : Cork +EVA
 3 Sections
 Quikik Lock



TP714-3
 Length:26"-53"(65-135cm)
 Diameter: 18/16/14mm
 Handle Grip : EVA
 3 Sections
 Twist Lock



TP713-3
 Length:26"-53"(65-135cm)
 Diameter: 18/16/14mm
 Handle Grip+pp
 3 Sections
 Quick Lock



TP714-4
 Length:21"-50"(53-125cm)
 Diameter:16/14/12/10mm
 Handle Grip : EVA
 4 Sections
 Twist Lock

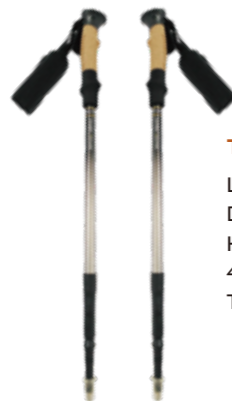

TP721-4
 Length:24"-51"(60-130cm)
 Diameter:18/16/14mm
 Handle Grip : Cork +EVA
 4 Sections
 Twist Lock



TP725-3
 Length:26"-53"(65-135cm)
 Diameter: 18/16/14mm
 Handle Grip : Cork +pp
 3 Sections
 Quikik Lock



TIPS: HANDLE USE

- EVA** EVA grips absorb moisture and provide a smooth comfortable grip.
- Rubber** Full sense of grip, harder in winter, easy to crack, do not have sweat-absorbent function (Wicking Function), summer easy to slip;
- Cork** Full sense of grip, not affected by the season, the material has a sweat-absorbing function (Wicking Function), but easy to wear and tear
- Plastic** Poor grip, easy to crack in winter, easy slip in summer, but the cost is low, cheap and convenient.



ACCESSORIES FOR ALL YOUR HIKING NEEDS



LIGHTWEIGHT INFLATABLE SLEEPING MAT

Outdoor Activity | Durable To Use | Easy To Fold



CQD08C85

Size: 73"x24 "x3.4"(185x60x8.5cm)
Material: 40DnylonTPU
Weight: 500g



valve



Inflatable



package

IT CAN BE APPLIED IN EVERY PLACE

COMFORTABLE AND EASY TO CARRY



GRASS LAND



SEASIDE



DESERT



TENT



WATERPROOF

Material: 40DnylonTPU

>>

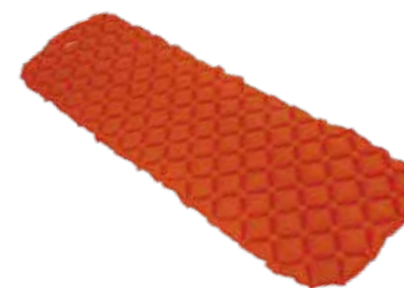

CQD13B50

Size:5.7"x2"x1.7"(175x58x5cm)
Weight:500g



CQD14B60

Size:6"x2"x0.2"(188x60x6cm)
Weight:420g



CQD09C85

Size:6"x2.6"x0.3"(185x80x8.5cm)
Weight:800g

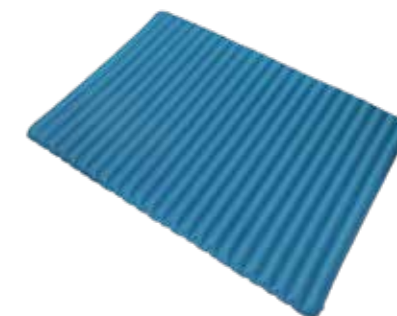

CQD10C85

Size:6"x4.3"x0.3"(185x130x8.5cm)
Weight:1100g

Material: 75D Polyester Pongee/210T PVC

>>



CQD03Y

Size:76"x52"x1.2"(192x132x3cm)
Weight:2600g



CQD01P25

Size:6"x2"x0.1"(186x58x2.5cm)
Weight:960g



CQD05G30
Size: 6.3"x2"x0.1"(190x62x3cm)
Weight: 1200g



CQD02G50
Size: 6.3"x2"x0.2"(192x63x5cm)
Weight: 1500g



CQD06G30
Size: 6.1"x2"x0.1"(186x58x3cm)
Weight: 960g



CQD11B120
Size: 6.3"x2"x0.2"(190x60x6cm)
Weight: 1200g

Customizable colors



Carton: 48x25x36cm 12pcs/cnts



ULTRA-LIGHT PILLOW



ZT05
Material: 30D laminated polyester coated TPU
Inflated Dimensions: 17"x13"x5.5"(44x32x14cm)
Weight: 86g

- Compact, Ultralight And Durable
- Improved Ergonomic Design
- Easy To Inflate And Deflate
- Comfortable And Slip-resistant Material



Material: 30D laminated polyester coated TPU

Material: PVC



ZT03
Inflated Dimensions: 14"x12"x3"(36x31x11cm)
Weight:



ZT01
Material: 210T diamond ripstop polyester PVC
Size: 17"x14"x3"(43x34x8cm)
Weight:



ZT06
Inflated Dimensions: 17.3"x5"x6"(44x32x14cm)
Weight: 86g



ZT02
Material: Suede polyester coated PVC
Size: 20"x12"x3"(50x30x8cm)
Weight:



ZT04
Inflated Dimensions: 14"x12"x4.4"(36x31x11cm)
Weight: 53g



ZT07
Material: PVC flocking pillow
Size: 35"x11"(90x28cm)
Weight: 130g



TENT

Dreaming of the outdoors



Window ventilation

SILICON COATING TENT

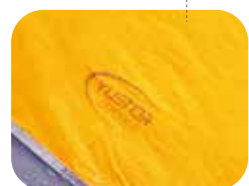

Waterproof



Stake hole

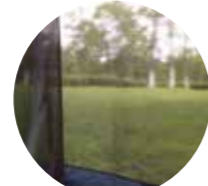

High Density

YZP08

Size:78.7"x59"x43.3"
 Outer:20D Silicon Coating Water Proof Fabric Pu3000mm
 Floor: 210T Polyester Pu3000mm
 Poles: Aluminum 7.9mm Poles
 Accessories : Aluminum Pegs With 2 Pcs Of Ropes
 Packing Size : 20"x7" (50x18cm)



Light

YZP01

Size(Outer) 55.1' x(82.7'+ 19.7') x 45.3'
 Outer tent : 210TPU3000 Waterproof Polyester
 Inner tent: 210T Breathable Polyester
 Floor: 210D Oxford Cloth Pu3000
 Pole: 8.5mm Fiberglass
 Weight: 2.5kgs
 Accessories: Pegs+rope



YZP02

Size 82.7"x82.7"x81.2"
 Fly Shell:180T Polyester Pu1000mm
 Inner: 170T Polyester Pa300mm&170tb/f
 Floor: Pe 110g/m2
 Mesh: B3
 Pole: Fgp 8.5mm&7.9mm
 Weight: 2.8kg



YZP03

Size(Outer) 84.6"x84.6"x53.1"
 Size(Inner): 74.8"x74.8"x53.1"
 Outer Tent: 190tpolyester Pu3000
 Inner Tent: 190tpolyester +b3 Mesh
 Floor: 210d Oxford Cloth
 Pole: Automatic Fiberglass
 Weight: 3.5kgs



YZP04

Size(Outer) Fly: (21.7'+83.9'+21.7')x70.9'x47.2'
 Material(Outer): Polyester 190t 1500mm Pu Wr
 Fly: Polyester 1000mm Pu Wr
 Material(Floor): P/oxf150d 1000mm Pu Wr
 Pole: Steel Pole 16mm
 Weight: 4.3kgs





YZP05

Size(Outer) 79.9"x32.7"x37.4"
 Outer tent: Polyester 450mm Pu Wr
 Mesh: 68x68 Mesh
 Floor: Pe Sheet,10x10
 Pole: Fiberglass 8.5mm
 Weight: 8.6kgs

YZP16

Fabric :
 Outer - 190T Polyester with PU coating
 Inner - 190T breathable Polyester
 Sewn in 120gm² Polyethylene groundsheet
 Dimensions :
 Outer - 560 x 300 x 198cm
 Inner - 540 x 280 x 188cm
 Bedroom - 210 x 280 x 188cm
 Poles: 4 x 12.7mm & 2 x 9.5mm Fibreglass
 Colours: Green / Charcoal
 Weight: 16.3kg
 HH: 3000
 Packaging Type: Swing Tag



YZP06

Size(Outer) 78.7"x47.2"x33.5"
 Material(Outer): 185tpolyester Pu1500+b3 Mesh
 Material(Floor):150d Oxford Pu3000
 Pole: Solid Fiberglass
 Weight: 2kgs

YZP31

Fabric :
 Outer - 190T PU3000mm polyester with heated seams
 Inner - 190T breathable Polyester
 Mesh : B3 mesh
 Groundsheet : 150D Oxford polyester
 Double floor layers
 Dimensions :
 Outer - 480 x 220 x 180cm
 Inner - 210 x 185 x 160cm
 Poles: Diameter 11cm air beams, 16mm iron tubes
 Colours: Blue and Grey
 Weight: 8kg
 Packaging Type:Carry bag



YZP07

Size : 260*210*114cm
 Fabric : 190t Pu2000mm
 Floor 120g Pe
 Poles : 6.0mm Fiberglass

SZP03

PORTABLE BEACH SHELTER
 SIZE : 74.8"x43.3"x39.4"
 MATERIAL(outer):
 170T PA300 polyester uv30+
 MATERIAL(floor):
 PE cloth:105g/m2
 POLE: D6.9mm fiberglass
 WEIGHT: 1kgs
 ACCESSORIES: pegs
 PACKAGE:
 1.1pc/carry bag
 2.12pcs/CTN
 3.size:55*34*20cm
 4.G.W/N.W:13/12KG



YZP09

Size:200*150*110cm
 Fabric:20d silicon coating water proof fabric pu3000mm
 Floor: 210t polyester pu3000mm
 With storage bags
 Fire warning label
 With 2 doors
 Poles: aluminum 7.9mm poles
 Aluminum pegs with 2 pcs of ropes
 Packing size : 50*18cm

TM01

SIZE(outer) 365X365X230CM
 MATERIAL(outer): Polyester 185T
 1000mm PU WR
 MESH: 68*68 mesh
 POLE: Fiberglass 11mm&9.5mm steel pole 19mm
 WEIGHT: 7.8kgs





TENT STAKE

Don't Let Your Tent Blow Away In The Wind



Material: Aluminum Tent Stake

7075/ 7001/ 6061/ Aluminum

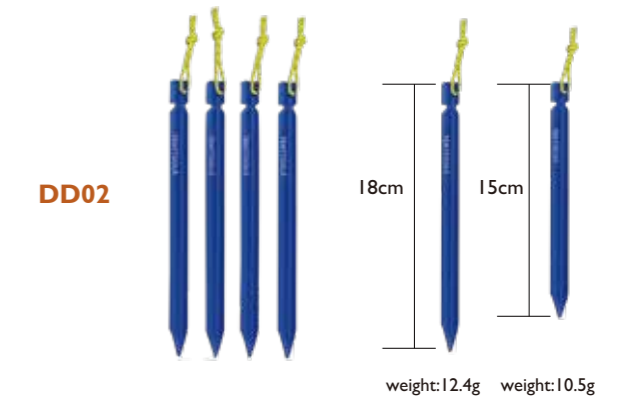
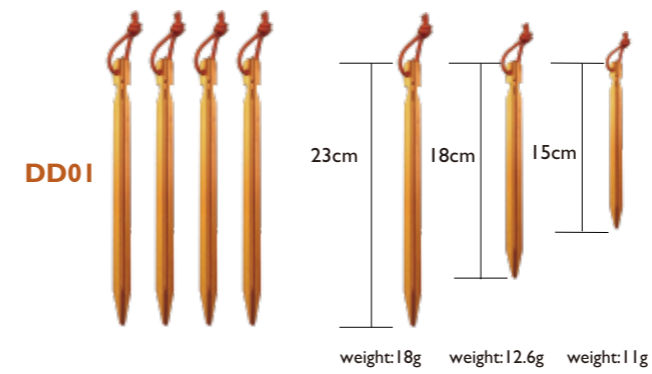

Material: Forged Steel Tent Stake

DD12

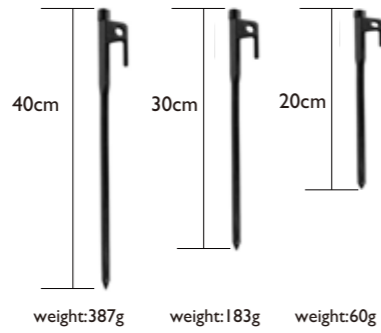

weight:387g weight:183g weight:60g



DD13

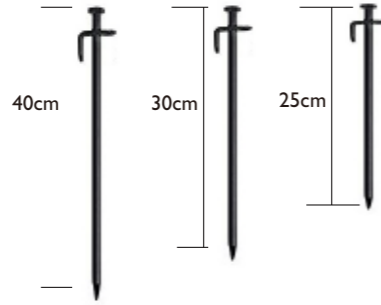

weight:210g weight:164g weight:139g



Material: Stainless Steel Tent Stake

DD14

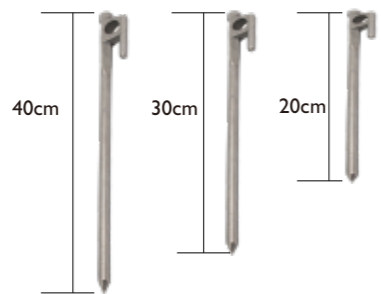

weight:218g weight:163g weight:93g

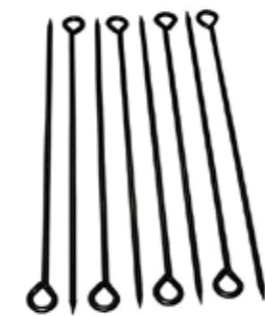

DD11-16

Length:18cm Weight:9.6g

Material: 7071 Aluminum

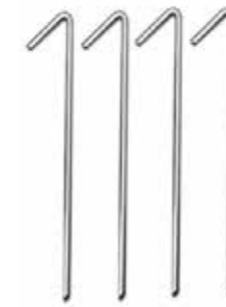

DD07-15

Length:16cm Weight:12.3g

Material: Titanium



DD04-16

Length:16cm Weight:11.8g

Material: Galvanized Stainless Steel



DD19-25

Length:25cm Weight:101g



DD18-25

Length:25cm Weight:109.2g

Material: ABS

DD16

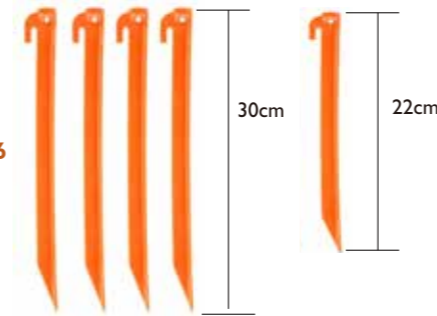

Weight:34.6g

Weight:21.6g



DD15-22

Length:18cm Weight:30g



DD17-15

Length:15cm Weight:22.2g

CAMPING COOKWARE & MESS KIT



OUTDOOR KITCHEN



GJA01

Using : 1~2person outdoor camping and picnic
Material: Anodized Aluminum

- Included: 1. pot: 5.9"x2.8"(150x72(h)mm)
2. frying pan: 6"x1.5"(152x37(h)mm)
3. bowl: 2pcs
4. spoon: 1pcs
5. slice: 1pcs
6. Loofah Sponge: 1pcs



GJA02

Using : 2~3person outdoor camping and picnic
Material: Anodized Aluminum

- Included: 1. Cauldron: 6.8"x3.5"(173x90(h)mm)
2. small pot: 5.9"x2.8"(150x 72(h))
3. frying pan: 7"x1.6"(179x40(h)mm)
3. bowl: 3pcs
4. spoon: 1pcs
5. slice: 1pcs
6. Loofah Sponge: 1pcs



GJA03



GJA03

Material: Aluminum alloy, hard anodized
Using: 5~6person camping and picnic
1. Cauldron: 192 * 110mm
2. middle pot: 173 * 90mm
3. small pot: 150*72mm
4. frying pan: 199* 49mm
5. spoon: 1pc
6. rice shovel: 1 pc
7. clean ball: 1 pc
8. bowl: 5pcs
9. plate: 2pcs
Packing: 1 set/mesh bag+color box

GJA04



GJA04

Material: Aluminum alloy, hard anodized
Using: 2~3persons camping and picnic
1. middle pot: 173*90mm
2. teapot: 150*80mm
3. frying pan: 179*40mm
5. spoon: 1pc
6. rice shovel: 1 pc
7. clean ball: 1 pc
8. bowl: 2pcs
Weight: 0.9kg
Packing: 1 set/mesh bag+color box

GJA06



GJA06

Material: Aluminum alloy, hard anodized
Using: 3~4person camping and picnic
1. large cup: 149 * 111mm
2. large bowl: 137*60mm
3. small cup: 134*100mm
4. small bowl: 122*59mm
5. clean ball: 1pc
Packing: 1 set/mesh bag+color box

GJA07



GJA07

Material: Aluminum alloy
Size: 14*dia20cm
Weight: 1.0kg
Volume: 5L
Packing: 1 pc/mesh bag+color box

GJA08



GJA08

Material: Aluminum alloy, hard anodized
Using: 6~7person camping and picnic
1. Hanging pot: 210*136mm
2. large pot: 193*120mm
3. middle pot: 173*91mm
4. small pot: 150*72mm
5. frying pan : 218*50mm
6. bowl: 6pcs
7. pan: 2pcs
8. spoon: 1pc
9. rice shovel: 1 pc
10. clean ball: 1pc
Packing: 1 set/mesh bag+color box

GJA09



GJA09

Material: Aluminum alloy, hard anodized
Using: 6~7person camping and picnic
1. Hanging pot: 210*136mm
2. large pot: 193*120mm
3. middle pot: 173*91mm
4. teapot: 1.1L
5. frying pan : 218*50mm
6. bowl: 6pcs
7. pan: 2pcs
8. spoon: 1pc
9. rice shovel: 1 pc
10. clean ball: 1pc
Packing: 1 set/mesh bag+color box

GJA10



GJA10

Material: Aluminum alloy, hard anodized
Using : 1~2person camping and picnic
1. 1.4L pot with cover: Φ 165x82mm
2. 6.2" fry pan: Φ 165*37mm
3. bowl: 2pcs
4. spoon: 1pc
5. dishcloth: 1pc
Weight: 536g
Packing: 1set/carry bag+color box

GJA11



GJA11

Material: Aluminum alloy
Using: 3~4person camping and picnic
1. large pot: dia 17.2*10cm
Volume: 2.2L
2. small pot: dia 15.5*8.5cm
Volume: 1.2L
3. frying pan: dia 15.5*4cm
4. teapot: dia 13*7.5cm
Volume: 0.8L
5. clean cloth
Weight: 1200g
Include two lids
Packing: 1set/cloth bag+color box

GJA22



GJA22

Material: Aluminium Alloy
Volume: 1.7L pot+1.4L pot+7.5"pan
Contain: 2pcs pot+pan+lit+gripper
+windshield+stand+spirit burner
Weight: 952g
Pack Size: 21.5*11*21.5cm
Package: 1 pc/Strap+mesh bag+color box



GJA13



GJA14

GJA13

Material: Hard anodizing aluminum +Stainless steel
 1.large pot: dia 17*10cm
 Volume: 1.4L
 2.small pot: dia 16*3.5cm
 Weight: 340g
 Packing: 1 pc/mesh bag+color box

GJA17

Material: Aluminum alloy
 Using: 3~4person camping and picnic
 1.large pot: 900ml
 2.small pot: 345ml
 Pack size: 14*14*17cm
 Weight: 260g
 Packing: 1 pc/mesh bag+color box



GJA17



GJA18

GJA18

Material:Hard anodized aluminum
 1.large pot: 2.2L
 2.middle pot: 1.2L
 3.small pot: 1L
 4.frying pan: 7.5 inch
 Pack size: 19.5*19.5*14
 Weight: 945g
 Include 3lids
 Packing: 1 set/mesh bag+color box



GJA15



GJA14

Material: Aluminum alloy
 Using: 4~6person camping and picnic
 Size: dia23.1*18.2cm
 Weight: 740g
 Volume: 6.5L
 Packing: 1 pc/mesh bag+color box

GJA19

Material:Hard anodized aluminum
 1.large pot: 16.3x9.2cm
 2.small pot: 14x8cm
 3.large frying pan: 16.5x4.7cm
 4.small frying pan: 14.3x4.1cm
 5.spoons: 1 pc
 6.rice shovel: 1 pc
 7.bowl: 3 pcs
 8.clean ball: 1 pc
 Weight: 820g
 Packing: 1 pc/oxford cloth+color box



GJA19



GJA20

GJA20

Material: Aluminum alloy
 Size: 15x8cm
 Volume: 1.1L
 Weight: 150g
 Packing: 1 set/mesh bag+color box

GJA21

Material: Aluminum alloy
 Size: 15x10cm
 Volume: 1.4L
 Weight: 292g
 Packing: 1 set/mesh bag+color box



GJA21



GJT01

GJT01

Material:Titanium
 Pot size: 11.7x11cm
 Volume: 1000ml
 Pan(lid) size: 11.7x4.8cm
 Volume: 500ml
 Colorbox size: 14x14x16cm
 Packing: 1 pc/carry bag+color box

GJA23

Material: Hard anodized aluminum+steel
 Size: 12x8.4cm(Spirit burner)
 Volume: 1.4L Kettle
 Weight: 322g
 Package: 1 pc/mesh bag+color box



GJA23





CJ01



CJ02



CJ03



CJ04



CJ05



CJ06



CJ07



CJ08

CJ01 Material: Stainless steel + plastic
Size: 15.5cm
Blade length: 6cm
Weight: 100g
Packing: 1 pc/opp bag+white box

CJ02 Material: 430 Stainless Steel+ABS
Size: 10*5cm
Weight: 138g
Packing: 1 pc/oxford cloth

CJ03 Material: 2cr13 Stainless Steel
Fold Size: 11cm
Weight: 152g
Packing: 1 pc/opp bag+white box

CJ04 Material: Stainless steel
Include: Knife, fork, spoon
Fold length: 9.5cm
Open size: 16cm
Weight: 84g
Packing: 1 pc/opp bag+black nylon bag

CJ05 Material: 410 stainless steel
430 stainless steel(chopsticks)
Chopsticks: 18.4cm W: 12.5g
Spoons: 17.5*3.7cm W: 23.5g
Fork: 17.7*2.4cm W: 21g
Package size: 20*6cm
Weight: 75g
Packing: 1 pc/cloth bag

CJ06 Material: Stainless Steel
Knife: 22.6cm W: 67g
Spoons: 20.6*4.5cm W: 47g
Fork: 20.6*2.8cm W: 40g
Packing: 1 pc/pe bag

CJ07 Material: ABS Plastic
Chopsticks: 18.8cm
Spoons: 16.8cm
Fork: 16.8cm
Package size: 12*5.7*2.2cm
Weight: 75g
Packing: 1 pc/box

CJ08 Material: ABS Plastic
Size: 4.8*2.8*12cm
Weight: 55g
Packing: 1 pc/box

CJ09 Material: 430 stainless steel(spoon)
+201 stainless steel(handle)
Size: 15*4cm
Fold length: 9.2cm
Weight: 29g
Packing: 1 pc/opp bag

CJ10 Material: Pure Titanium
Size: 16.5*3.5*0.2cm
Weight: 15g
Packing: 1 pc/opp bag

CJ11 Material: Stainless steel
Size: 15.5*6.8*0.18cm
Weight: 110g
Packing: 1 pc/pvc bag

WJ01 Material: 201 Stainless Steel
Size: 17.8*6cm
Weight: 75g
Packing: 1 pc/opp bag

WJ02 Material: 201 Stainless Steel
Size: 21.3*4cm
Weight: 96g
Packing: 1 pc/opp bag

WJ03 Material: silicone
Open size: dia20.8*11cm
Weight: 200g
Packing: 1 pc/opp bag

BJ01 Material: 201 Stainless Steel
Size: 7.8*7.3cm
Volume: 280ml
Weight: 51g
Packing: 1 pc/white box

BJ02 Material: Silicone
Size: dia7.5*8.5cm
Weight: 38g
MOQ: 2000pcs
A plastic circle on the waist
Packing: 1 pc/opp bag



CJ09



CJ10



CJ11



WJ01



WJ02



WJ03



BJ01



BJ02



OUTDOOR KITCHEN Kitchen Accessories

Camping Stove OUTDOOR KITCHEN



CHJ01



CHJ02



CHJ03



CHJ04



CHJ05



CHJ06

CHJ01 Pack Size:
14.6"x8.3"x2.4(37x21x6cm)
Weight: 965g

CHJ02 Material: Silica Gel + Stainless Steel
Spatula: 36x8.2cm W: 92g
Scoops: 35.5x10cm W: 100g
Soup ladle: 31.5x9cm W: 98g
Pink spoon: 34.5x6.2cm W:84g
Dense spoon: 35.2x7cm W:86g
Scraper: 33.5x5.5cm W: 82g
Clamp: 34x4cm W: 149g
Eggbeater: 31.5x6.5cm W:93g
Packing: 1 pc/color box

CHJ03 Material: Silica gel + stainless steel
Mein spoon: 28.8x5.2cm W:69g
Spoon: 29.8x8.8cm W:100g
Turner: 27.6x5.9cm W:72g
Leakage shovel:30.5x8cm W:80g
Oil brush: 19.5x3.4cm W:40g
Colander: 27.3x5.8cm W:73g
Food clip: 27.2x3.6cm W:110g
Egg beater: 27.5x6.7cm W:41g
Butter spreader:27x5.3cm W:88g
Small knife: 20.5x4cm W:43g
Package size: 32.5x10x7.5cm
Weight: 0.9kg
Packing: 1 pc/color box

CHJ04 Material: Plastic+Stainless Steel
Size: 13.5x5.5x2.7cm
Weight: 62g
Packing: 1 pc/tied card packaging

CHJ05 Material: PP
Size: dia 15cm
Weight: 47g
Packing: 1 pc/pe bag

CHJ06 Material: Hard anodized Aluminum
Size: 133.5cm
Weight: 1100g
Package: 1 pc/nylon bag+color box

LT01 Material: stainless steel +copper
+aluminum alloy
Size(folded): 8x8x6cm
Size(unfolded): 14.5*12.5*6cm
Weight: 233g
Power: 3500W
Packing: 1 pc/plastic box

LT02 Material: stainless steel
Size(folded): 4.5*4*7.5cm
Size(unfolded): 8.5*8.5*7.5cm
Weight: 96g
Packing: 1 pc/plastic box

LT03 Material: stainless steel, copper
aluminum alloy
Size(folded): 8.6*8.6*8.3cm
Size(unfolded): 14.4*12.5*8.3cm
Weight: 270g
Power: 3500W
Packing: 1 pc/plastic box

LT04 Material: stainless steel
Size(folded): 7.4*8.3cm
Size(unfolded): 15*13*8.3cm
Weight: 280g
Power: 2900W
Packing: 1 pc/plastic box
then into a color box

LT05 Material: Titanium alloy,copper
Fuel: Butane
Open size: 8.5*6.85cm
Fold size: 3.7*5.2cm
Weight: 25g
Packing: 1 pc/plastic box+cloth bag

LT06 Material: stainless steel+ aluminum aloy
Size(folded): 6*3cm
Size(unfolded): dia9.4*7.8cm
Weight: 40g
Packing: 1 pc/black plastic box



LT01



LT02



LT03



LT04



LT05



LT06

**FOCUS ON
OUTDOOR
CAMPING PRO**

