



金日盛[®] FSJRS
HARDWARE PRODUCTS

COMBINE

TO CREATE THE FASHIONABLE PRODUCTS

演绎出精雅脱俗的时尚产品

so graceful and so refined

ABOUT OUR



佛山市国正五金制品有限公司(金日盛FSJRS)品牌,是一间具有专业生产经验的技术型企业,拥有先进的生产设备与专业的技术人才。企业以生产、营销、科研于一体,产品销售遍及全国及世界各地,受到客户一致好评。

金日盛品牌,通过多年研发与拓展“金日盛”系列产品,安全耐用可靠,适应各种安装技术要求,已在业界享有一定的知名度,深得广大用户一致信赖。本着精益求精,所有产品都是采用优质材料生产精制而成,符合国家质量监督检测标准。

本公司抱着认真、负责、锐意进取的态度,保证产品质量一流的售后服务,赢取天下客户的赞誉,为客户作出最大的保证。同时诚邀与各新老客户通力合作,共同拓展。

FSJRS hardware products co., ltd is a technological enterprises with over professional of production experience. It has advanced production equipment and a group of qualified technical personnel. Enterprise integrates production, sales and scientific research, its products are sold throughout the country and around the world, and get high praised by customers.

Through years of research and development, FSJRS series product is safe, durable and reliable. These products are capable of satisfying various installation requirements. They have high reputation in the industry and deeply trusted by customers. Based on the spirit of excellence, all products are refined from high quality materials production, and conform to the quality supervision and testing standards.

With conscientious, responsible and enterprising attitudes, the company guarantees best product quality and first-class after-sales services and wins praises of customers around the world. We sincerely hope of fully cooperate with old and new customers, to achieve mutual progress.

金日盛®
FSJRS
HARDWARE PRODUCTS

FSJRS

STAIRCASE

GRASPING THE PULSE OF THE TIMES, DEMONSTRATING FASHIONABLE LIFE
紧扣时代脉搏,演绎时尚生活



[工程案例]

凝聚思维元素，缔造尊贵生活
CREATE VALUED LIFE

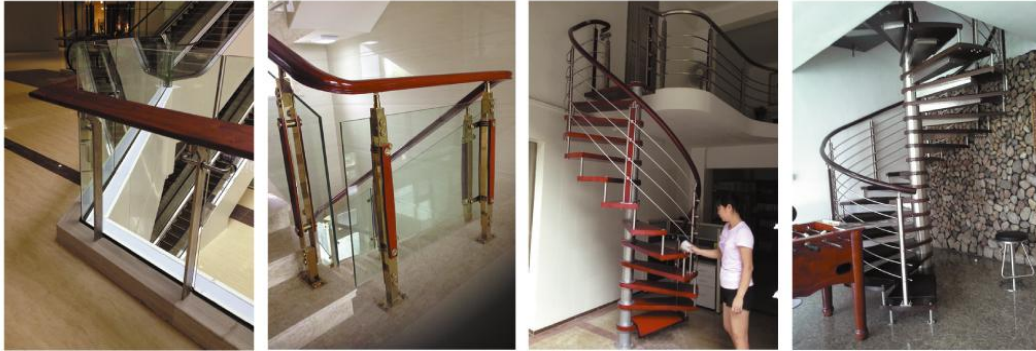

[企业证书]

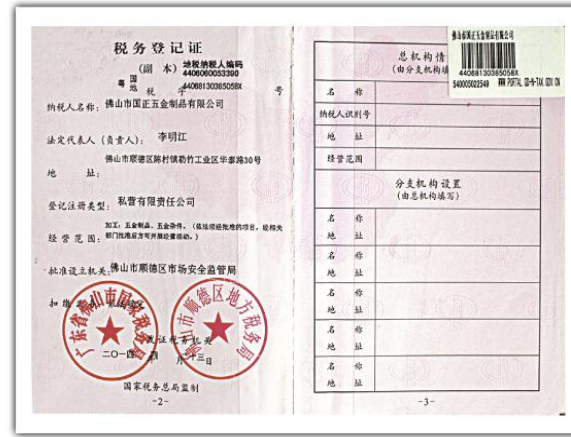

Diamond

钻石
Derive from diamond inspiration, create diamond quality
源自钻石灵感, 打造钻石品质



Every piece of brilliant and splendid diamond is from the endless inspiration and consummate craftsmanship of world-class masters. The ordinary original stone, through carving, sends out attractive brilliance and charm. Using the inspiration, efforts, and patience of diamond cutting to design every piece of staircase, is an ultimate experience of staircase design.

每一颗璀璨夺目的极品钻石, 都来自于世界钻石大师无穷的灵感和精湛的工艺, 平凡的原石经过雕琢, 散发出最迷人的光辉和极度诱惑的魔力。用切割钻石的灵感、努力和耐心来设计每一件楼梯, 就是一场楼梯设计的终极体验。

01 不锈钢工程系列

STAINLESS PROJECT SERIES
SERIES
P01-P20



03 不锈钢家装系列

STAINLESS HOUSE DECORATE SERIES
P55-P70



04 将军柱系列

Samson Posts SERIES
P71-P79

02 不锈钢精品系列

BEST STAINLESS SERIES
P21-P54



05 铝合金夹木系列

Aluminum alloy sandwich SERIES
P80-P120

金日盛304



STAINLESS PROJECT SERIES
SERIES
 不锈钢工程系列



表面处理: 砂光、镜光
 Finish: satin, mirror light

主要材质: 不锈钢
 Material: Stainless steel

主要功能: 玻璃与栏杆固定连接
 Function: Connect glass and baluster

安装方式: 膨胀螺栓地面安装
 Installation method: Floor mounting by the expansion bolt



Size(mm)			
A	B	C	D
850	220	420	210

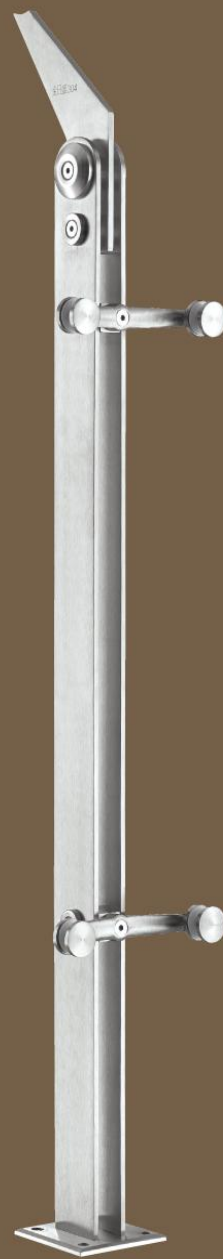

JRS-8001

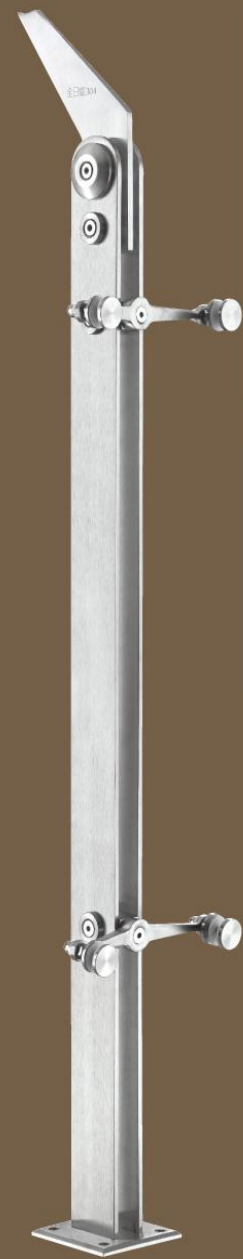

JRS-8002



表面处理: 砂光、镜光
 Finish: satin, mirror light

主要材质: 不锈钢
 Material: Stainless steel

主要功能: 玻璃与栏杆固定连接
 Function: Connect glass and baluster

安装方式: 膨胀螺栓地面安装
 Installation method: Floor mounting by the expansion bolt



Size(mm)			
A	B	C	D
850	220	420	210





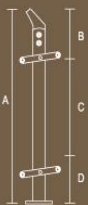

-  表面处理: 砂光、镜光
Finish: satin, mirror light
-  主要材质: 不锈钢
Material: Stainless steel
-  主要功能: 玻璃与栏杆固定连接
Function: Connect glass and baluster
-  安装方式: 膨胀螺栓地面安装
Installation method: Floor mounting by the expansion bolt

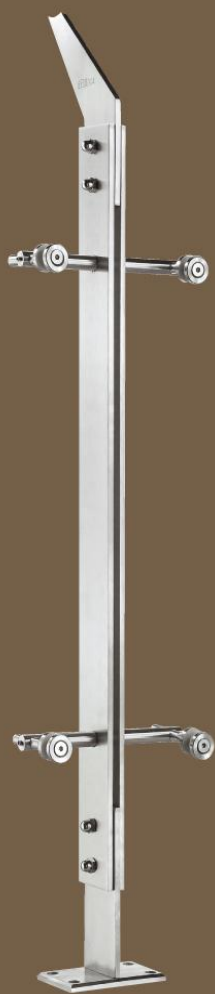

Size(mm)			
A	B	C	D
850	220	420	210

JRS-8003



-  表面处理: 砂光、镜光
Finish: satin, mirror light
-  主要材质: 不锈钢
Material: Stainless steel
-  主要功能: 玻璃与栏杆固定连接
Function: Connect glass and baluster
-  安装方式: 膨胀螺栓地面安装
Installation method: Floor mounting by the expansion bolt

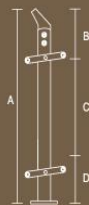

Size(mm)			
A	B	C	D
850	220	420	210

JRS-8004



-  表面处理: 砂光、镜光
Finish: satin, mirror light
-  主要材质: 不锈钢
Material: Stainless steel
-  主要功能: 玻璃与栏杆固定连接
Function: Connect glass and baluster
-  安装方式: 膨胀螺栓地面安装
Installation method: Floor mounting by the expansion bolt

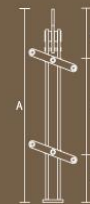

Size(mm)			
A	B	C	D
850	220	420	210

JRS-8005



表面处理: 砂光、镜光
Finish: satin, mirror light

主要材质: 不锈钢
Material: Stainless steel

主要功能: 玻璃与栏杆固定连接
Function: Connect glass and baluster

安装方式: 扁螺螺丝地面安装
Installation method: Floor mounting by the expansion bolt

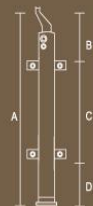

Size(mm)			
A	B	C	D
850	220	420	210

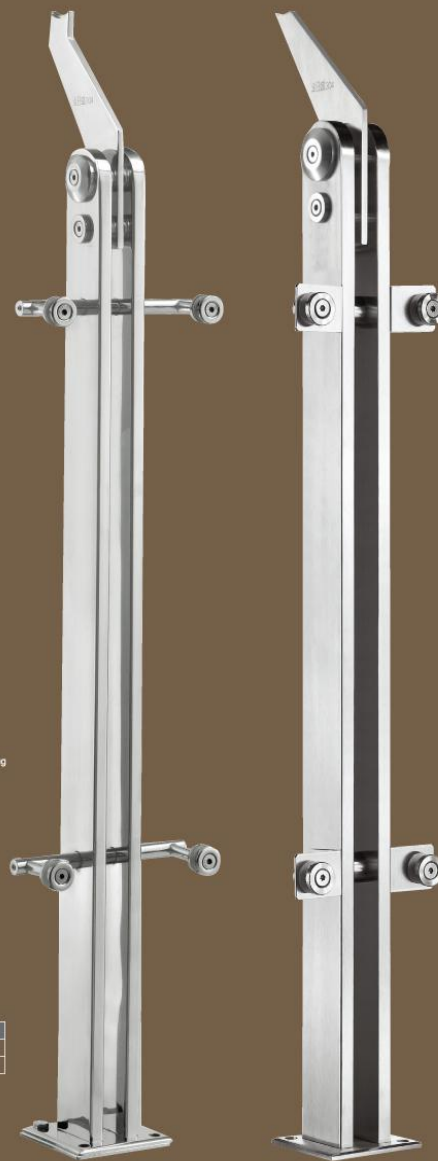

JRS-8006

JRS-8007



表面处理: 砂光、镜光
Finish: satin, mirror light

主要材质: 不锈钢
Material: Stainless steel

主要功能: 玻璃与栏杆固定连接
Function: Connect glass and baluster

安装方式: 扁螺螺丝地面安装
Installation method: Floor mounting by the expansion bolt



Size(mm)			
A	B	C	D
850	220	420	210





- 表面处理: 砂光、镜光
Finish: satin, mirror light
- 主要材质: 不锈钢
Material: Stainless steel
- 主要功能: 玻璃与栏杆固定连接
Function: Connect glass and baluster
- 安装方式: 膨胀螺丝地面安装
Installation method: Floor mounting by the expansion bolt

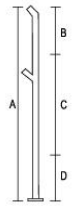

Size(mm)			
A	B	C	D
850	220	420	210

JRS-8008



- 表面处理: 砂光、镜光
Finish: satin, mirror light
- 主要材质: 不锈钢
Material: Stainless steel
- 主要功能: 玻璃与栏杆固定连接
Function: Connect glass and baluster
- 安装方式: 膨胀螺丝地面安装
Installation method: Floor mounting by the expansion bolt

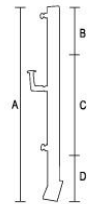

Size(mm)			
A	B	C	D
850	220	420	210

JRS-8009



- 表面处理: 砂光、镜光
Finish: satin, mirror light
- 主要材质: 不锈钢
Material: Stainless steel
- 主要功能: 玻璃与栏杆固定连接
Function: Connect glass and baluster
- 安装方式: 膨胀螺丝地面安装
Installation method: Floor mounting by the expansion bolt



Size(mm)			
A	B	C	D
850	220	420	210

JRS-8010

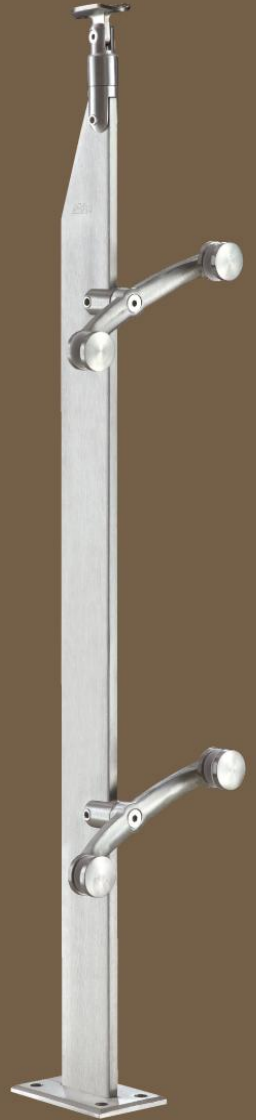

- 表面处理: 砂光、镜光
Finish: satin, mirror light
- 主要材质: 不锈钢
Material: Stainless steel
- 主要功能: 玻璃与栏杆固定连接
Function: Connect glass and baluster
- 安装方式: 膨胀螺丝地面安装
Installation method: Floor mounting by the expansion bolt



Size(mm)			
A	B	C	D
850	220	420	210

JRS-8011



-  表面处理: 砂光、镜光
Finish: satin, mirror light
-  主要材质: 不锈钢
Material: Stainless steel
-  主要功能: 玻璃与栏杆固定连接
Function: Connect glass and baluster
-  安装方式: 膨胀螺丝地面安装
Installation method: Floor mounting by the expansion bolt



Size(mm)			
A	B	C	D
850	220	420	210

JRS-8012



-  表面处理: 砂光、镜光
Finish: satin, mirror light
-  主要材质: 不锈钢
Material: Stainless steel
-  主要功能: 玻璃与栏杆固定连接
Function: Connect glass and baluster
-  安装方式: 膨胀螺丝地面安装
Installation method: Floor mounting by the expansion bolt



Size(mm)			
A	B	C	D
850	220	420	210

JRS-8013



-  表面处理: 砂光、镜光
Finish: satin, mirror light
-  主要材质: 不锈钢
Material: Stainless steel
-  主要功能: 玻璃与栏杆固定连接
Function: Connect glass and baluster
-  安装方式: 膨胀螺丝地面安装
Installation method: Floor mounting by the expansion bolt



Size(mm)			
A	B	C	D
850	220	420	210

JRS-8014



表面处理: 砂光、镜光
Finish: satin, mirror light

主要材质: 不锈钢
Material: Stainless steel

主要功能: 玻璃与栏杆固定连接
Function: Connect glass and baluster

安装方式: 膨胀螺栓地面安装
Installation method: Floor mounting by the expansion bolt



Size(mm)			
A	B	C	D
850	220	420	210



JRS-8015



表面处理: 砂光、镜光
Finish: satin, mirror light

主要材质: 不锈钢
Material: Stainless steel

主要功能: 玻璃与栏杆固定连接
Function: Connect glass and baluster

安装方式: 膨胀螺栓地面安装
Installation method: Floor mounting by the expansion bolt

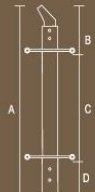

Size(mm)			
A	B	C	D
850	220	420	210



JRS-8016





表面处理: 砂光、镜光
Finish: satin, mirror light

主要材质: 不锈钢
Material: Stainless steel

主要功能: 玻璃与栏杆固定连接
Function: Connect glass and baluster

安装方式: 膨胀螺栓地面安装
Installation method: Floor mounting by the expansion bolt



Size(mm)			
A	B	C	D
850	220	420	210

JRS-8017



表面处理: 砂光、镜光
Finish: satin, mirror light

主要材质: 不锈钢
Material: Stainless steel

主要功能: 玻璃与栏杆固定连接
Function: Connect glass and baluster

安装方式: 膨胀螺栓地面安装
Installation method: Floor mounting by the expansion bolt



Size(mm)			
A	B	C	D
850	220	420	210

JRS-8018

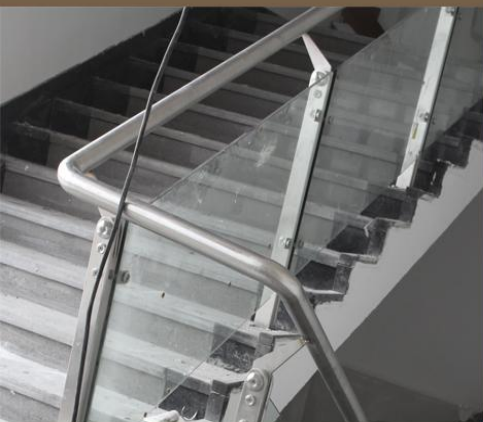

JRS-8019

表面处理: 砂光、镜光
Finish: satin, mirror light

主要材质: 不锈钢
Material: Stainless steel

主要功能: 玻璃与栏杆固定连接
Function: Connect glass and baluster

安装方式: 膨胀螺栓地面安装
Installation method: Floor mounting by the expansion bolt

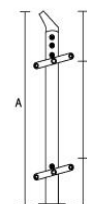

Size(mm)			
A	B	C	D
850	220	420	210



表面处理: 砂光、镜光
Finish: satin, mirror light

主要材质: 不锈钢
Material: Stainless steel

主要功能: 玻璃与栏杆固定连接
Function: Connect glass and baluster

安装方式: 膨胀螺栓地面安装
Installation method: Floor mounting by the expansion bolt



Size(mm)			
A	B	C	D
850	220	420	210



JRS-8020

表面处理: 砂光、镜光
Finish: satin, mirror light

主要材质: 不锈钢
Material: Stainless steel

主要功能: 玻璃与栏杆固定连接
Function: Connect glass and baluster

安装方式: 膨胀螺栓地面安装
Installation method: Floor mounting by the expansion bolt

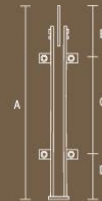

Size(mm)			
A	B	C	D
850	220	420	210

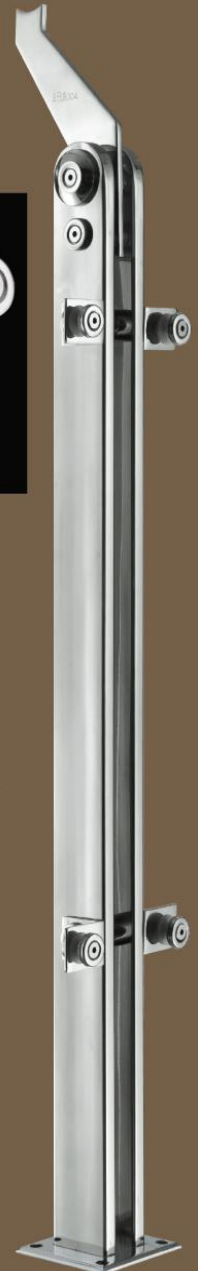

JRS-8021



表面处理: 砂光、镜光
Finish: satin, mirror light

主要材质: 不锈钢
Material: Stainless steel

主要功能: 玻璃与栏杆固定连接
Function: Connect glass and baluster

安装方式: 膨胀螺丝地面安装
Installation method: Floor mounting by the expansion bolt

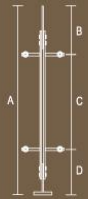

Size(mm)			
A	B	C	D
850	220	420	210

JRS-8022



表面处理: 砂光、镜光
Finish: satin, mirror light

主要材质: 不锈钢
Material: Stainless steel

主要功能: 玻璃与栏杆固定连接
Function: Connect glass and baluster

安装方式: 膨胀螺丝地面安装
Installation method: Floor mounting by the expansion bolt



Size(mm)			
A	B	C	D
850	220	420	210

JRS-8023



表面处理: 砂光、镜光
Finish: satin, mirror light

主要材质: 不锈钢
Material: Stainless steel

主要功能: 玻璃与栏杆固定连接
Function: Connect glass and baluster

安装方式: 膨胀螺丝地面安装
Installation method: Floor mounting by the expansion bolt



Size(mm)			
A	B	C	D
850	220	420	210

JRS-8024



表面处理: 砂光、镜光
Finish: satin, mirror light

主要材质: 不锈钢
Material: Stainless steel

主要功能: 玻璃与栏杆固定连接
Function: Connect glass and baluster

安装方式: 膨胀螺丝地面安装
Installation method: Floor mounting by the expansion bolt

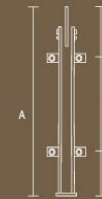

Size(mm)			
A	B	C	D
850	220	420	210

JRS-8025



JRS-8640



JRS-8641



金日藏304

金日藏®
HARDWARE PRODUCTS

BEST STAINLESS
SERIES
不锈钢精品系列

-  表面处理: 砂光、镜光
Finish: satin, mirror light
-  主要材质: 不锈钢
Material: Stainless steel
-  主要功能: 玻璃与栏杆固定连接
Function: Connect glass and baluster
-  安装方式: 膨胀螺丝地面安装
Installation method: Floor mounting by the expansion bolt



Size(mm)			
A	B	C	D
850	220	420	210





JRS-8026

-  表面处理: 砂光、镜光
Finish: satin, mirror light
-  主要材质: 不锈钢
Material: Stainless steel
-  主要功能: 玻璃与栏杆固定连接
Function: Connect glass and baluster
-  安装方式: 膨胀螺丝地面安装
Installation method: Floor mounting by the expansion bolt



Size(mm)			
A	B	C	D
850	220	420	210

JRS-8027

-  表面处理: 砂光、镜光
Finish: satin, mirror light
-  主要材质: 不锈钢
Material: Stainless steel
-  主要功能: 玻璃与栏杆固定连接
Function: Connect glass and baluster
-  安装方式: 膨胀螺丝地面安装
Installation method: Floor mounting by the expansion bolt

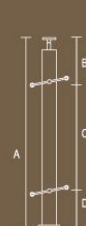

Size(mm)			
A	B	C	D
850	220	420	210

JRS-8028



金日藏®
FSJRS
HARDWARE PRODUCTS



表面处理: 砂光、镜光
Finish: satin, mirror light

主要材质: 不锈钢
Material: Stainless steel

主要功能: 玻璃与栏杆固定连接
Function: Connect glass and baluster

安装方式: 膨胀螺丝地面安装
Installation method: Floor mounting by the expansion bolt



Size(mm)			
A	B	C	D
850	220	420	210

JRS-8029



表面处理: 砂光、镜光
Finish: satin, mirror light

主要材质: 不锈钢
Material: Stainless steel

主要功能: 玻璃与栏杆固定连接
Function: Connect glass and baluster

安装方式: 膨胀螺丝地面安装
Installation method: Floor mounting by the expansion bolt



Size(mm)			
A	B	C	D
850	220	420	210

JRS-8030



表面处理: 砂光、镜光
Finish: satin, mirror light

主要材质: 不锈钢
Material: Stainless steel

主要功能: 穿拉丝
Function: Through drawing

安装方式: 膨胀螺丝地面安装
Installation method: Floor mounting by the expansion bolt



Size(mm)			
A	B	C	D
850	220	420	210

JRS-8031



JRS-8032

表面处理: 砂光、镜光
Finish: satin, mirror light

主要材质: 不锈钢
Material: Stainless steel

主要功能: 穿拉丝
Function: Through drawing

安装方式: 膨胀螺丝地面安装
Installation method: Floor mounting by the expansion bolt



Size(mm)			
A	B	C	D
850	220	420	210



-  表面处理: 砂光、镜光
Finish: satin, mirror light
-  主要材质: 不锈钢
Material: Stainless steel
-  主要功能: 穿拉丝
Function: Through drawing
-  安装方式: 膨胀螺栓地面安装
Installation method: Floor mounting by the expansion bolt



Size(mm)			
A	B	C	D
850	220	420	210

-  表面处理: 砂光、镜光
Finish: satin, mirror light
-  主要材质: 不锈钢
Material: Stainless steel
-  主要功能: 玻璃与栏杆固定连接
Function: Connect glass and baluster
-  安装方式: 膨胀螺栓地面安装
Installation method: Floor mounting by the expansion bolt



Size(mm)			
A	B	C	D
850	220	420	210

-  表面处理: 砂光、镜光
Finish: satin, mirror light
-  主要材质: 不锈钢
Material: Stainless steel
-  主要功能: 穿拉丝
Function: Through drawing
-  安装方式: 膨胀螺栓地面安装
Installation method: Floor mounting by the expansion bolt





Size(mm)			
A	B	C	D
850	220	420	210

JRS-8033

JRS-8034

JRS-8035



-  表面处理: 砂光、镜光
Finish: satin, mirror light
-  主要材质: 不锈钢
Material: Stainless steel
-  主要功能: 玻璃与栏杆固定连接
Function: Connect glass and baluster
-  安装方式: 膨胀螺丝地面安装
Installation method: Floor mounting by the expansion bolt

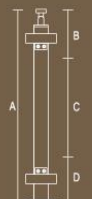

Size(mm)			
A	B	C	D
850	220	420	210

JRS-8036

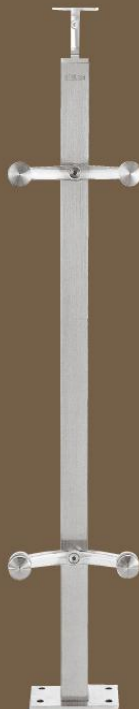

-  表面处理: 拉丝/镜光/PVD
Finish: Satin/Polish/PVD
-  主要材质: SUS304/SUS316不锈钢
Material: SUS304/SUS316 Stainless Steel
-  主要功能: 栏杆
Function: Railing
-  安装方式: 膨胀螺丝地面安装
Installation method: Floor mounting by the expansion bolt

Size(mm)			
A	B	C	D
850	220	420	210

JRS-8037





-  表面处理: 砂光、镜光
Finish: satin, mirror light
-  主要材质: 不锈钢
Material: Stainless steel
-  主要功能: 穿拉丝
Function: Through drawing
-  安装方式: 膨胀螺丝地面安装
Installation method: Floor mounting by the expansion bolt

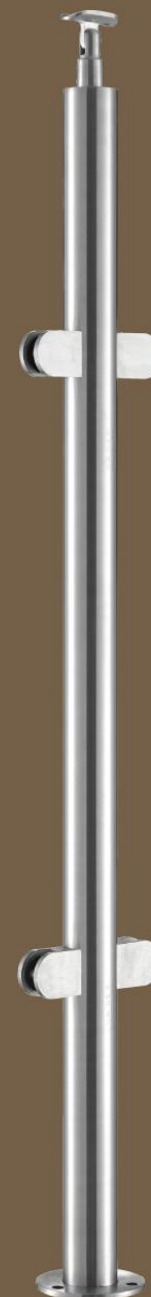

Size(mm)			
A	B	C	D
850	220	420	210

JRS-8038



-  表面处理: 砂光、镜光
Finish: satin, mirror light
-  主要材质: 不锈钢
Material: Stainless steel
-  主要功能: 玻璃与栏杆固定连接
Function: Connect glass and baluster
-  安装方式: 膨胀螺丝地面安装
Installation method: Floor mounting by the expansion bolt



Size(mm)			
A	B	C	D
850	220	420	210

JRS-8039

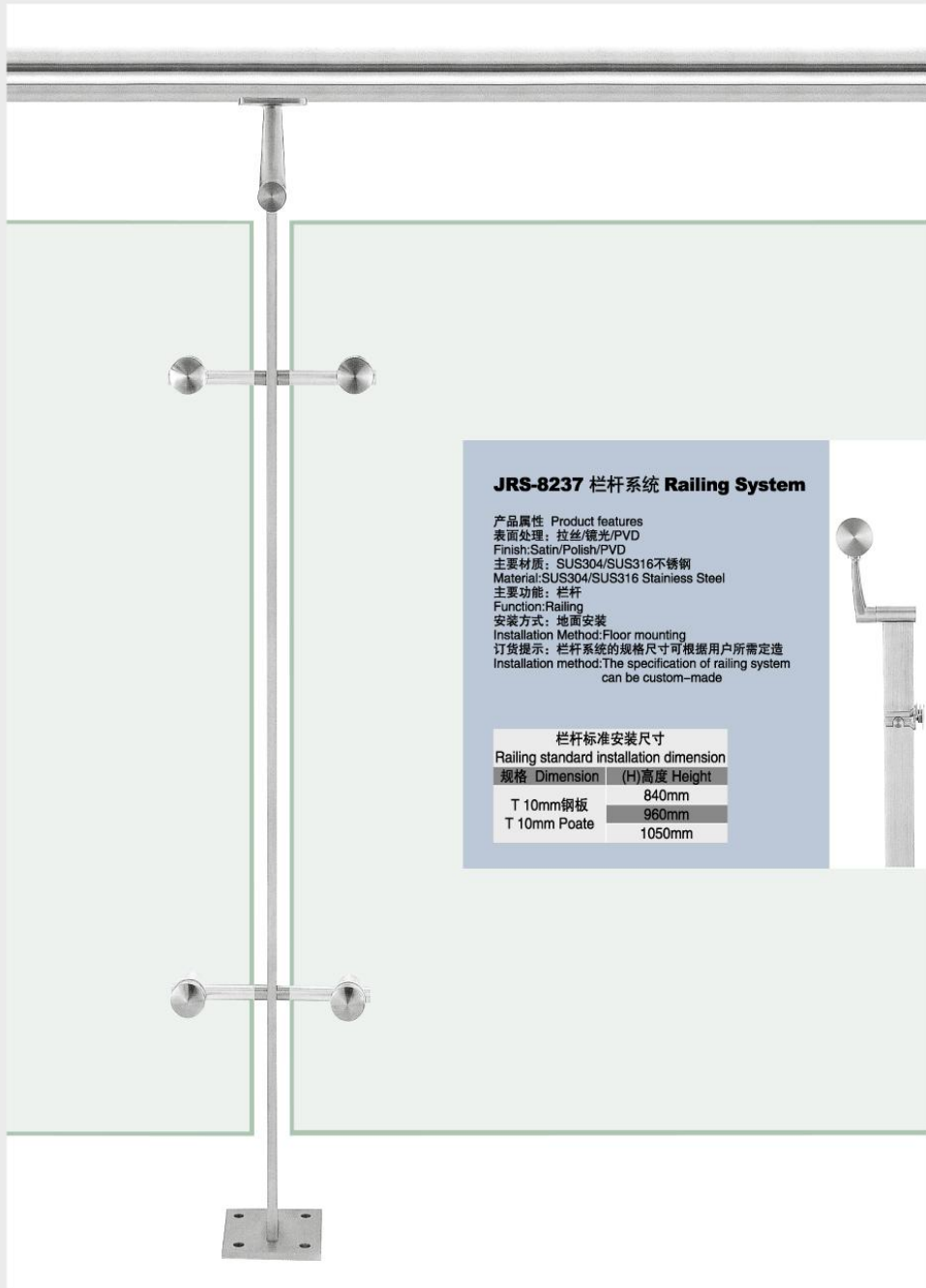

JRS-8237 栏杆系统 Railing System

产品属性 Product features
 表面处理: 拉丝/镜光/PVD
 Finish: Satin/Polish/PVD
 主要材质: SUS304/SUS316不锈钢
 Material: SUS304/SUS316 Stainless Steel
 主要功能: 栏杆
 Function: Railing
 安装方式: 地面安装
 Installation Method: Floor mounting
 订货提示: 栏杆系统的规格尺寸可根据用户所需定造
 Installation method: The specification of railing system can be custom-made



栏杆标准安装尺寸	
Railing standard installation dimension	
规格 Dimension	(H)高度 Height
T 10mm钢板	840mm
T 10mm Poate	960mm
	1050mm

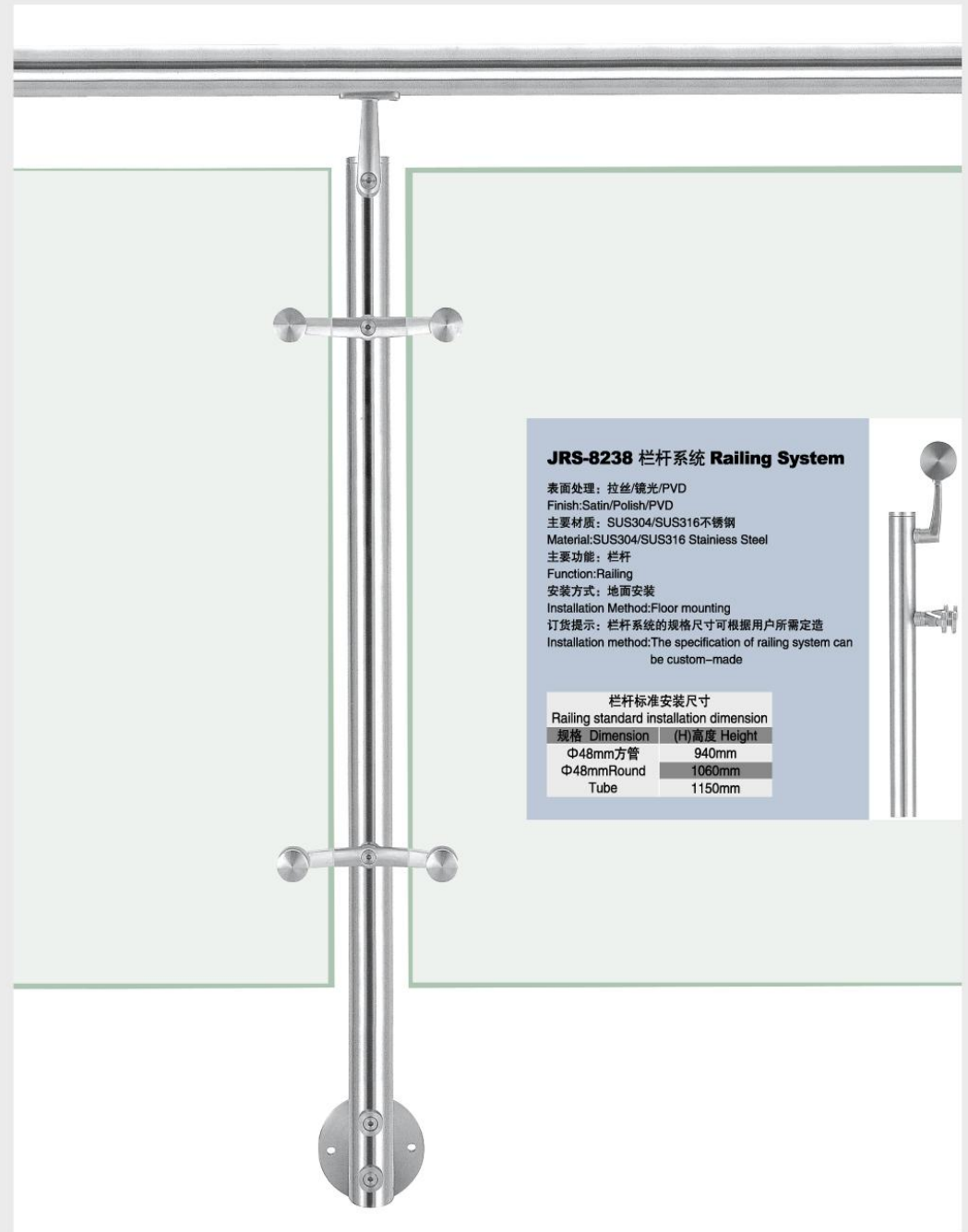

JRS-8238 栏杆系统 Railing System

表面处理: 拉丝/镜光/PVD
 Finish: Satin/Polish/PVD
 主要材质: SUS304/SUS316不锈钢
 Material: SUS304/SUS316 Stainless Steel
 主要功能: 栏杆
 Function: Railing
 安装方式: 地面安装
 Installation Method: Floor mounting
 订货提示: 栏杆系统的规格尺寸可根据用户所需定造
 Installation method: The specification of railing system can be custom-made



栏杆标准安装尺寸	
Railing standard installation dimension	
规格 Dimension	(H)高度 Height
Φ48mm方管	940mm
Φ48mm Round Tube	1060mm
	1150mm

JRS-8239系列护栏，应用于玻璃填充系统
JRS-8239 Series Railing Glass Infill System Application

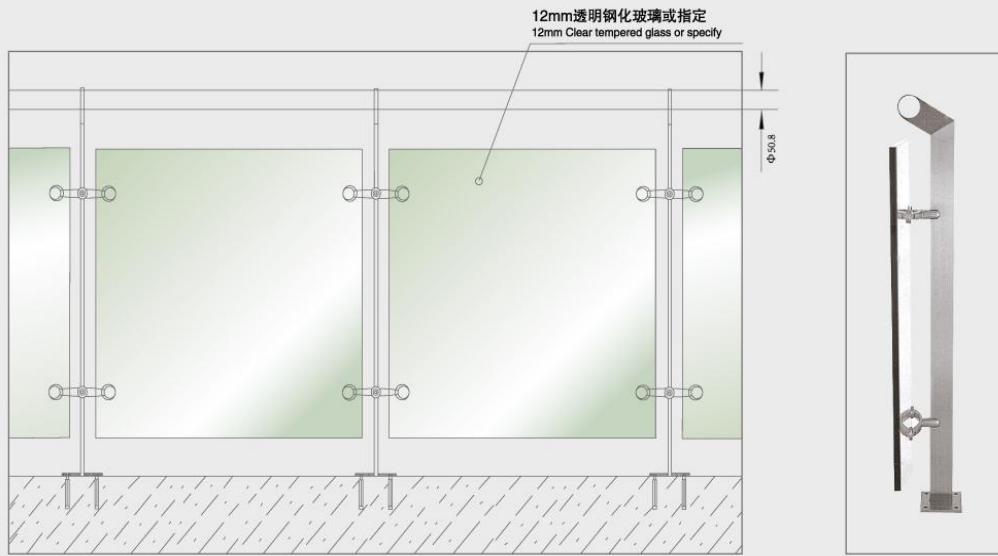

JRS-8239

可选安装方式 Option Installation Methods

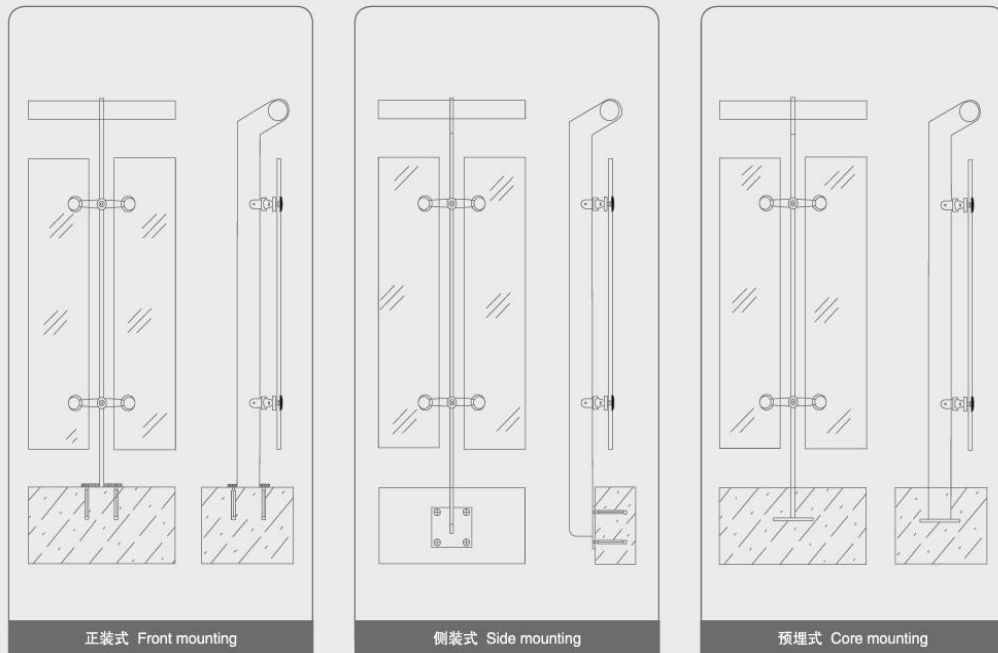

JRS-8240系列护栏，应用于玻璃填充系统
JRS-8240 Series Railing Glass Infill System Application

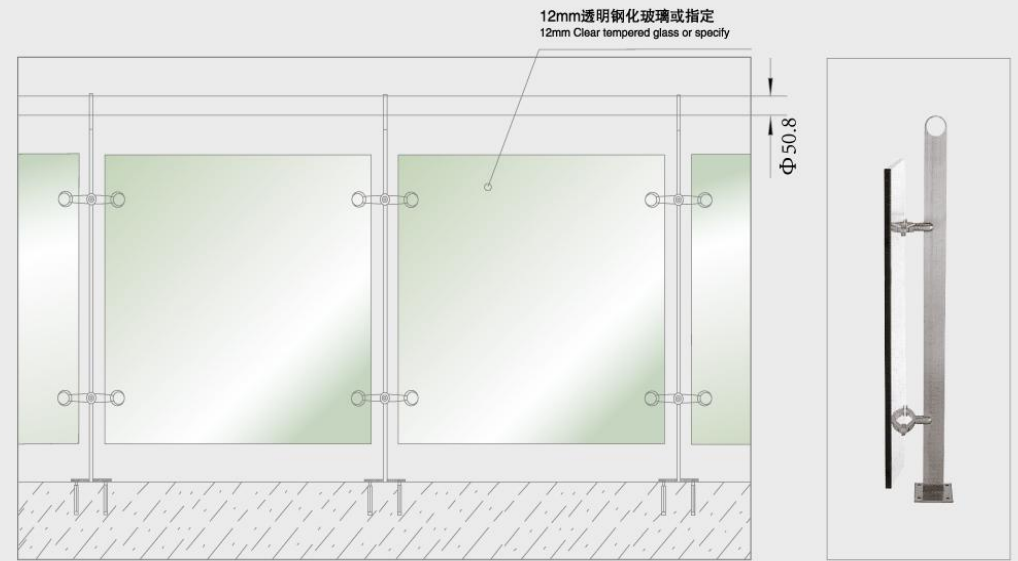

JRS-8240

可选安装方式 Option Installation Methods

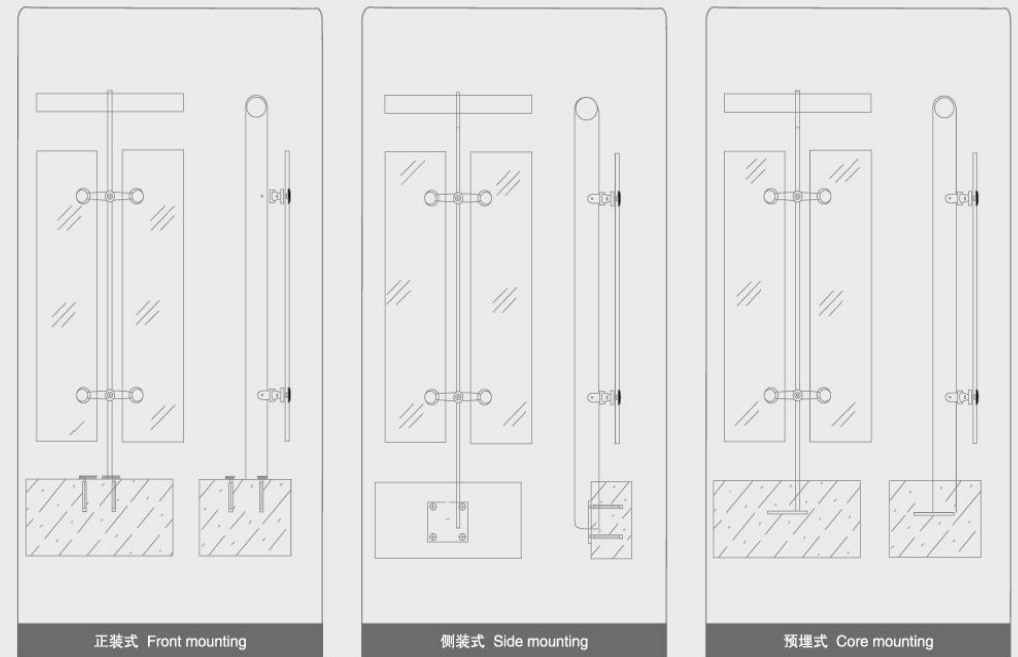

可选功能配置 Option function collocation



JRS-8241

JRS-8242

JRS-8243

可选配件 Option Items

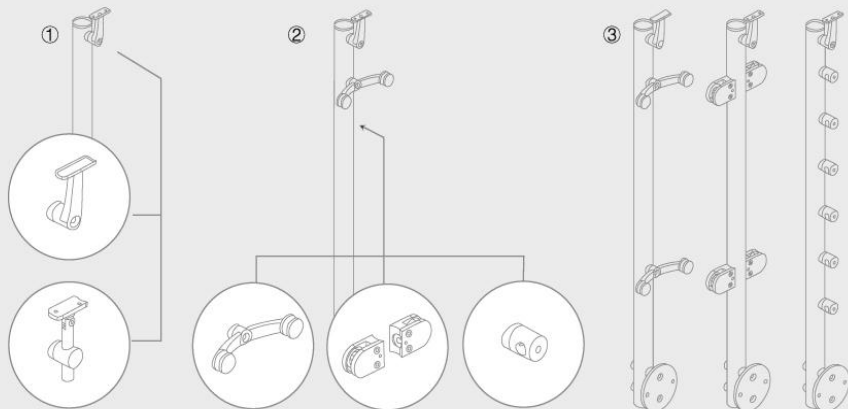

JRS-8244系列护栏, 应用于玻璃填充系统

JRS-8244 Series Railing Glass Infill System Application

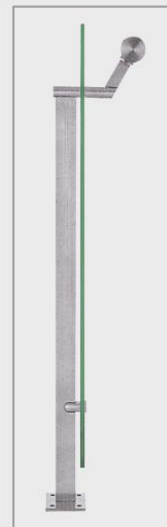
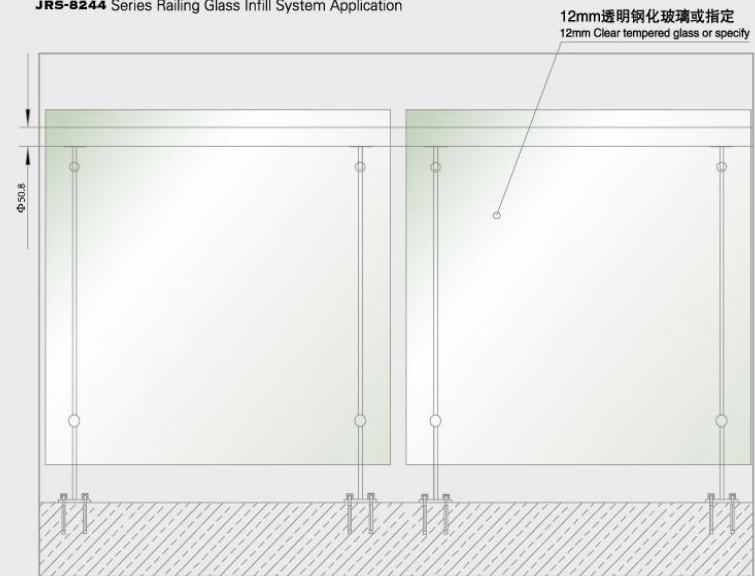

JRS-8244

可选安装方式 Option Installation Methods

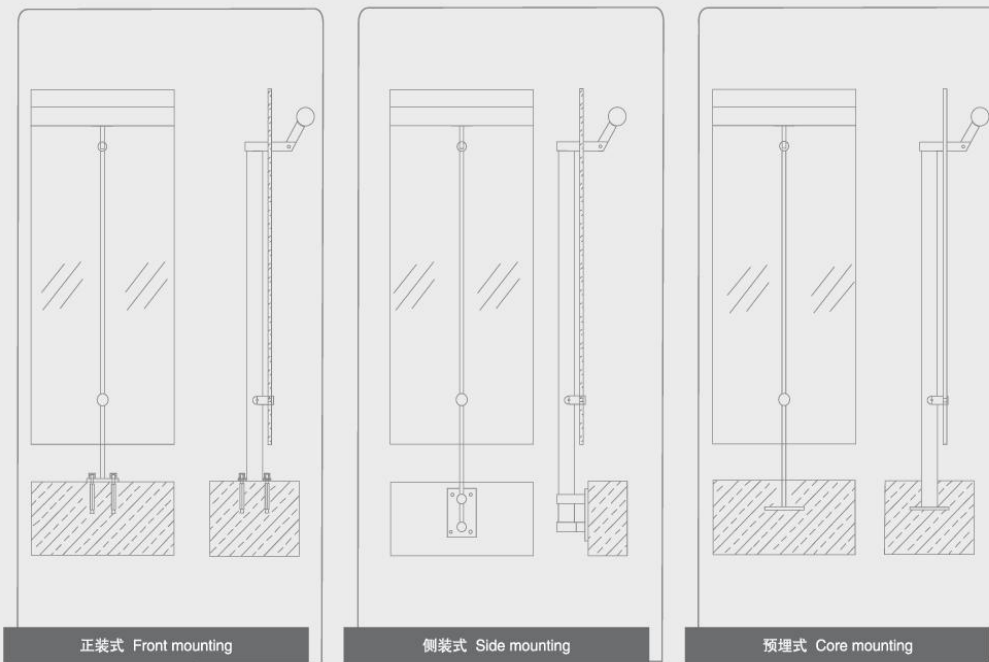

正装式 Front mounting

侧装式 Side mounting

预埋式 Core mounting



JRS-8601 有槽扶手直接 Slotted armrest directly

产品属性 Product features

- 表面处理: 拉丝/镜光/PVD
Finish:Satin/Polish/PVD
- 主要材质: SUS304/SUS316不锈钢
Material:SUS304/SUS316 Stainless Steel
- 主要功能: 扶手与栏杆灵活角度固定连接
Function:Connect handrail and baluster at flexible angle

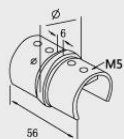

JRS-8605 有槽扶手万能接头 Slotted armrest universal jointt

产品属性 Product features

- 表面处理: 拉丝/镜光/PVD
Finish:Satin/Polish/PVD
- 主要材质: SUS304/SUS316不锈钢
Material:SUS304/SUS316 Stainless Steel
- 主要功能: 扶手与栏杆灵活角度固定连接
Function:Connect handrail and baluster at flexible angle



JRS-8602 90° 有槽扶手接头 90° grooved rail joint

产品属性 Product features

- 表面处理: 拉丝/镜光/PVD
Finish:Satin/Polish/PVD
- 主要材质: SUS304/SUS316不锈钢
Material:SUS304/SUS316 Stainless Steel
- 主要功能: 扶手管与墙90° 固定连接
Function:Use for round tube handrail and wall at90° connection

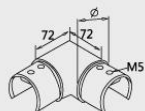

编号 Code	Φ
SK-3634-51	Φ50.8

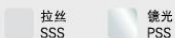

JRS-8606 有槽扶手扣件 slotted Handrail fastener

产品属性 Product features

- 表面处理: 拉丝/镜光/PVD
Finish:Satin/Polish/PVD
- 主要材质: SUS304/SUS316不锈钢
Material:SUS304/SUS316 Stainless Steel
- 主要功能: 扶手管与墙90° 固定连接
Function:Use for round tube handrail and wall at90° connection

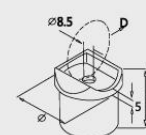

编号 Code	Φ
SK-3634-51	Φ50.8

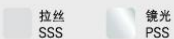

JRS-8603 90° 有槽扶手接头 90° grooved rail joint

产品属性 Product features

- 表面处理: 拉丝/镜光/PVD
Finish:Satin/Polish/PVD
- 主要材质: SUS304/SUS316不锈钢
Material:SUS304/SUS316 Stainless Steel
- 主要功能: 扶手管与墙灵活角度固定连接
Function:Use for round tube handrail and wall at flexible angle

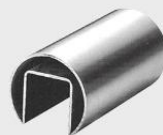
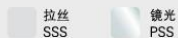

JRS-8607 圆形有槽扶手 Rounded grooved armrest

产品属性 Product features

- 表面处理: 拉丝/镜光/PVD
Finish:Satin/Polish/PVD
- 主要材质: SUS304/SUS316不锈钢
Material:SUS304/SUS316 Stainless Steel
- 主要功能: 扶手管与墙灵活角度固定连接
Function:Use for round tube handrail and wall at flexible angle

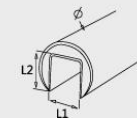

JRS-8604 有槽扶手封口 Slotted armrest sealing

产品属性 Product features

- 表面处理: 拉丝/镜光/PVD
Finish:Satin/Polish/PVD
- 主要材质: SUS304/SUS316不锈钢
Material:SUS304/SUS316 Stainless Steel
- 主要功能: 扶手管与墙灵活角度固定连接
Function:Use for round tube handrail and wall at flexible angle

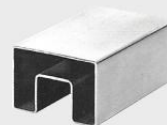
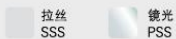
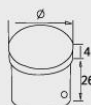

JRS-8608 方形有槽扶手 Square slotted armrest

产品属性 Product features

- 表面处理: 拉丝/镜光/PVD
Finish:Satin/Polish/PVD
- 主要材质: SUS304/SUS316不锈钢
Material:SUS304/SUS316 Stainless Steel
- 主要功能: 扶手管与墙灵活角度固定连接
Function:Use for round tube handrail and wall at flexible angle

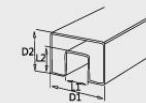

专业栏杆系统 PROFESSIONAL RAILING SYSTEM

JRS-8609 球座活动扶手托架 Adjustable Handrail Bracket



拉丝 SSS 镜光 PSS

产品属性 Product features

- 表面处理: 拉丝/镜光/PVD
Finish: Satin/Polish/PVD
- 主要材质: SUS304/SUS316不锈钢
Material: SUS304/SUS316 Stainless Steel
- 主要功能: 扶手与栏杆灵活角度固定连接
Function: Connect handrail and baluster at flexible angle
- 安装方式: 圆管栏杆上简易安装
Installation method: Fixed on the round tube baluster by easy hit



JRS-8610 上墙法兰 Wall Flange



拉丝 SSS 镜光 PSS

产品属性 Product features

- 表面处理: 拉丝/镜光/PVD
Finish: Satin/Polish/PVD
- 主要材质: SUS304/SUS316不锈钢
Material: SUS304/SUS316 Stainless Steel
- 主要功能: 扶手管与墙90° 固定连接
Function: Use for round tube handrail and wall at 90° connection
- 安装方式: 墙上安装
Installation method: Wall mounting

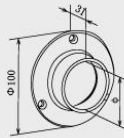

编号 Code	Φ
SK-3634-51	Φ50.8

JRS-8611 活动上墙接头 Activities on the wall joint



拉丝 SSS 镜光 PSS

产品属性 Product features

- 表面处理: 拉丝/镜光/PVD
Finish: Satin/Polish/PVD
- 主要材质: SUS304/SUS316不锈钢
Material: SUS304/SUS316 Stainless Steel
- 主要功能: 扶手管与墙灵活角度固定连接
Function: Use for round tube handrail and wall at flexible angle
- 安装方式: 墙上安装
Installation method: Wall mounting

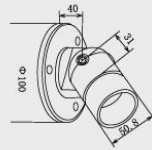

JRS-8612 活动扶手接头 Joint activities armrest



拉丝 SSS 镜光 PSS

产品属性 Product features

- 表面处理: 拉丝/镜光/PVD
Finish: Satin/Polish/PVD
- 主要材质: SUS304/SUS316不锈钢
Material: SUS304/SUS316 Stainless Steel
- 主要功能: 扶手管与墙灵活角度固定连接
Function: Use for round tube handrail and wall at flexible angle
- 安装方式: 圆管扶手之间金属胶水粘接安装
Installation method: Wall mounting



JRS-8613 活动扶手弯头 Adjustable Angle



拉丝 SSS 镜光 PSS

产品属性 Product features

- 表面处理: 拉丝/镜光/PVD
Finish: Satin/Polish/PVD
- 主要材质: SUS304/SUS316不锈钢
Material: SUS304/SUS316 Stainless Steel
- 主要功能: 扶手管灵活角度连接
Function: Use for round tube handrail at flexible angle connection
- 安装方式: 扶手管之间胶水粘接安装
Installation method: Fixed between the tubes by glue

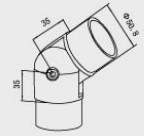

JRS-8614 活动扶手弯头 Adjustable Angle



拉丝 SSS 镜光 PSS

产品属性 Product features

- 表面处理: 拉丝/镜光/PVD
Finish: Satin/Polish/PVD
- 主要材质: SUS304/SUS316不锈钢
Material: SUS304/SUS316 Stainless Steel
- 主要功能: 扶手管灵活角度连接
Function: Use for round tube handrail at flexible angle connection
- 安装方式: 扶手管之间胶水粘接安装
Installation method: Fixed between the tubes by glue

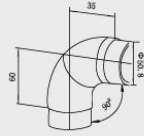

JRS-8615 活动扶手弯头 Adjustable Angle



拉丝 SSS 镜光 PSS

产品属性 Product features

- 表面处理: 拉丝/镜光/PVD
Finish: Satin/Polish/PVD
- 主要材质: SUS304/SUS316不锈钢
Material: SUS304/SUS316 Stainless Steel
- 主要功能: 扶手管灵活角度连接
Function: Use for round tube handrail at flexible angle connection
- 安装方式: 扶手管之间简易安装
Installation method: Fixed on the round tube handrails by easy hit

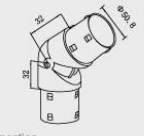

JRS-8616 135° 扶手弯头 135° Flush Elbow



拉丝 SSS 镜光 PSS

产品属性 Product features

- 表面处理: 拉丝/镜光/PVD
Finish: Satin/Polish/PVD
- 主要材质: SUS304/SUS316不锈钢
Material: SUS304/SUS316 Stainless Steel
- 主要功能: 扶手管135° 连接
Function: Use for round tube handrail at 135° connection
- 安装方式: 扶手管之间胶水粘接安装
Installation method: Fixed between the tubes by glue

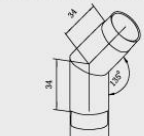

编号 Code	Φ
SK-3696-38	Φ38.1
SK-3669-42	Φ42.4
SK-3669-51	Φ50.8

JRS-8617 弯头管子封口 End Scroll



拉丝 SSS 镜光 PSS

产品属性 Product features

- 表面处理: 拉丝/镜光/PVD
Finish: Satin/Polish/PVD
- 主要材质: SUS304/SUS316不锈钢
Material: SUS304/SUS316 Stainless Steel
- 主要功能: 扶手管封口
Function: Use for Seal the ends of round tube handrail
- 安装方式: 圆管扶手胶水粘接安装
Installation method: Fixed on the round tube by glue

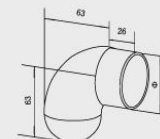

编号 Code	Φ
SK-3636-51	Φ50.8



[8613]

[8614]

[8611]



[8601]

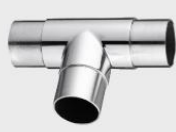

[8602]



[8603]



[8604]



[8605]



[8607]



[8608]



[8609]



[8610]



[8612]

专业栏杆系统 PROFESSIONAL RAILING SYSTEM

JRS-8618 方管封口盖 End Cap



拉丝
SSS

镜光
PSS

产品属性 Product features

表面处理: 拉丝/镜光/PVD
Finish: Satin/Polish/PVD

主要材质: SUS304/SUS316不锈钢
Material: SUS304/SUS316 Stainless Steel

主要功能: 方管扶手封口
Function: Seal the ends of square tube handrail

安装方式: 方管扶手上胶水粘结安装
Installation method: Fixed on the square tube handrails by glue

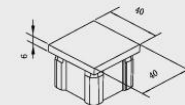

JRS-8619 方管扶手接驳头 Handrail Connector



拉丝
SSS

镜光
PSS

产品属性 Product features

表面处理: 拉丝/镜光/PVD
Finish: Satin/Polish/PVD

主要材质: SUS304/SUS316不锈钢
Material: SUS304/SUS316 Stainless Steel

主要功能: 方管扶手180° 接驳连接
Function: Connect the square tube at 180°

安装方式: 方管扶手之间胶水粘结安装
Installation method: Fixed on the square tube handrails by glue

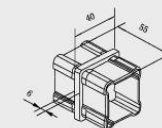

JRS-8620 扶手40方管90° 度弯头



拉丝
SSS

镜光
PSS

产品属性 Product features

表面处理: 拉丝/镜光/PVD
Finish: Satin/Polish/PVD

主要材质: SUS304/SUS316不锈钢
Material: SUS304/SUS316 Stainless Steel

主要功能: 方管扶手90° 接驳连接
Function: Connect the square tube at 90°

安装方式: 方管扶手之间胶水粘结安装
Installation method: Fixed on the square tube handrails by glue

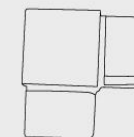

JRS-8621 活动双管扶手接头 Adjustable double pipe handrail connector



拉丝
SSS

镜光
PSS

产品属性 Product features

表面处理: 拉丝/镜光/PVD
Finish: Satin/Polish/PVD

主要材质: SUS304/SUS316不锈钢
Material: SUS304/SUS316 Stainless Steel

主要功能: 方管扶手灵活角度接驳连接
Function: Connect the square tube handrail at flexible angle

安装方式: 方管扶手之间胶水粘结安装
Installation method: Fixed on the square tube handrails by glue

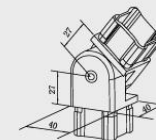

金日盛方管组件系列 JINRISHENG Square Tube Components Series

完美的方管组件系列
方管组件系列满足时下时尚栏杆系统的需求。你可以通过简单地组合这些组件，从而转换现有栏杆系统的外观，而不需要重新订购全部的栏杆。

Perfect Square Tube Components Series
Square Line meets today's demand for stylish railing systems. You can easily integrate these components to transform the appearance of existing systems without needing to replace the entire railing.



Model:[8615]

实心铸件活动头（镜光）



Model:[8616]

实心铸件活动头（砂光）

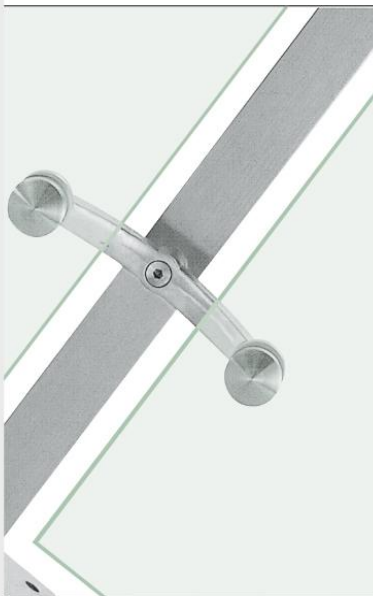

拉丝
SSS

镜光
PSS

JRS-8622 方形外装底座 Square Baluster Bracket

产品属性 Product features

表面处理: 拉丝/镜光/PVD
Finish: Satin/Polish/PVD

主要材质: SUS304/SUS316不锈钢
Material: SUS304/SUS316 Stainless Steel

主要功能: 栏杆与侧墙固定连接
Function: Connect and fix baluster to wall

安装方式: 墙上安装
Installation method: Wall mounting

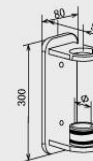

编号 Code	Φ
SK-3539-38	Φ38.1
SK-3539-42	Φ42.4
SK-3539-51	Φ50.8



拉丝
SSS

镜光
PSS

JRS-8623 圆形外装底座 Round Baluster Bracket

产品属性 Product features

表面处理: 拉丝/镜光/PVD
Finish: Satin/Polish/PVD

主要材质: SUS304/SUS316不锈钢
Material: SUS304/SUS316 Stainless Steel

主要功能: 栏杆与侧墙固定连接
Function: Connect and fix baluster to wall

安装方式: 墙上安装
Installation method: Wall mounting

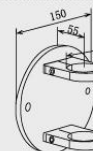

编号 Code	Φ
SK-3540-38	Φ38.1
SK-3540-42	Φ42.4
SK-3540-51	Φ50.8

JRS-8623安装示意图
Installation Sketch Map

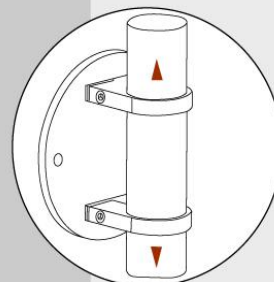



金日盛扶手弯头系统
JINRISHENG Handrail Elbow System

扶手弯头提供了一种安装栏杆扶手的快速、灵活的解决方案。

如果您有客户想让家或办公室体现当前最时尚的建筑那么不同的弯头可以让您的一要选择变成现实。

- 1、角度灵活：扶手弯头有灵活的调整角度功能，配合不同环境安装扶手。
- 2、所有嵌入式弯头，可以通过金属胶水粘给栏杆组件，而不需要表面粗糙的焊接工艺和费时的焊接过程。
- 3、超强的粘接力粘给建筑金属不留痕迹。

Elbow offers a quick, agile way to mount your railing solution.

If you have customers who want to keep up with the latest architectural trends in their home or office, elbow allows.

1. Angle adjustable: Handrail elbow series all these items with clever angle adjustable function, suitable for handrail installation under different conditions.
2. All flush elbows allow you to connect railing components by metal glue, instead of expensive welding tools and time-consuming processing.
3. It leaves a clean connection to secure metal constructions with unparalleled bonding power.



1

2

3

金日盛栏杆扶手座
JINRISHENG Handrail Saddle



除了时间和成本的明显付出，另一个焊接法的底线是不能犯错误或者变卦。也两种用于钻孔连接。如果地面不平，这些传统的方法将会导致不必要的耽误和损坏。

- 1、升降灵活：
扶手座提供灵活性的安装，不会浪费时间或者材料。比如我们护栏托架有灵活的升降功能。
- 2、嵌入式栏杆扶手座，可以通过金属胶水粘给，而不需要表面粗糙的焊接过程。
- 3、以其超强的粘接力牢固粘给建筑金属，不留痕迹。

Beyond the obvious issues of time and costs, another downside of welding is that there is no room for error...or second thoughts. The same applies to drilled connections. If the floors are not straight, these traditional approaches result in unnecessary delays and damages.

1. Clever Adjustable
Baluster bracket gives you the flexibility, without wasting or material. Our baluster brackets, have clever adjustable function to adjust the height of mounted balusters.
2. Flush baluster bracket allow you to connect railing components by metal glue, instead of expensive welding tools and time-consuming processing.
3. It leaves a clean connection to secure metal constructions with unparalleled bonding



[8620]



[8621]





Model:[8622]

Technique Points:
Materia:304#
材质: 304#
Finish:SSS、PSS、PVD
表面处理: 砂光、抛光、金色
Function: Tube Connector
功能: 扶手封口



Model:[8623]

Technique Points:
Materia:Aluminum
材质: 铝合金
Finish:Dark silver / champagne
表面处理: 灰银、香槟金、哑黑炭
Function: Aluminum Accessory
功能: 铝配件



Model:[8624]

Technique Points:
Materia:304#
材质: 304#
Finish:SSS、PSS、PVD
表面处理: 砂光、抛光、金色
Function: Tube Connector
功能: 扶手封口



Model:[8625]

Technique Points:
Materia:Aluminum
材质: 铝合金
Finish:Dark silver / champagne
表面处理: 灰银、香槟金、哑黑炭
Function: Aluminum Accessory
功能: 铝配件



Model:[8626]

Materia:SUS304 Stainless steel
材质: SUS 304不锈钢
Colour:SSS、PSS、PVD
颜色: 砂光、抛光、金色
Remark: Tube Connector
备注: 管连接件





金日盛扶手托架
JINRISHENG Handrail bracket



JRS-8624

用于扶手的支撑件经常受阻碍于保护方面的损坏。
金日盛栏杆系统提供固定墙扶手托架，以便你能够保留栏杆的原有风格。
安装快速简单，成本低而且时尚。

Supports for hand railings are often marred by interfering securing points.
JINRISHENG Offers blind wall attachments so that you can secure railings without deterring from the design. And thanks to the quick and easy installation, being stylish doesn't have its price.



JRS-8625

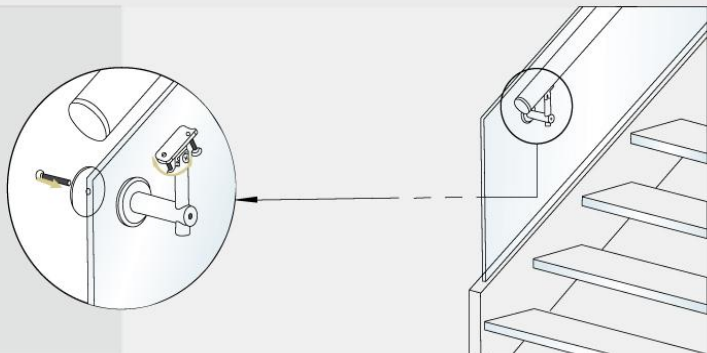

专业栏杆系统 PROFESSIONAL RAILING SYSTEM



拉丝 SSS 镜光 PSS

JRS-8626 活动扶手托架 Adjustable Handrail Bracket

产品属性 Product features

- 表面处理: 拉丝/镜光/PVD
Finish: Satin/Polish/PVD
- 主要材质: SUS304/SUS316不锈钢
Material: SUS304/SUS316 Stainless Steel
- 主要功能: 扶手与墙灵活角度固定连接, 可调节扶手高度
Function: Connect handrail and wall at flexible angle. height adjustable
- 安装方式: 墙上安装
Installation method: Wall mounting

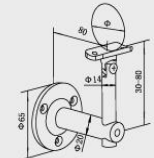

编号 Code	Φ
SK-3227-42	Φ42.4
SK-3227-51	Φ50.8



拉丝 SSS 镜光 PSS

JRS-8627 扶手托架 Handrail Bracket

产品属性 Product features

- 表面处理: 拉丝/镜光/PVD
Finish: Satin/Polish/PVD
- 主要材质: SUS304/SUS316不锈钢
Material: SUS304/SUS316 Stainless Steel
- 主要功能: 扶手与墙灵活角度固定连接, 可调节扶手高度
Function: Connect handrail and wall at flexible angle. height adjustable
- 安装方式: 墙上安装
Installation method: Wall mounting

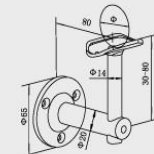

编号 Code	Φ
SK-3228-42	Φ42.4
SK-3228-51	Φ50.8



拉丝 SSS 镜光 PSS

JRS-8628 活动扶手托架 Adjustable Handrail Bracket

产品属性 Product features

- 表面处理: 拉丝/镜光/PVD
Finish: Satin/Polish/PVD
- 主要材质: SUS304/SUS316不锈钢
Material: SUS304/SUS316 Stainless Steel
- 主要功能: 扶手与墙灵活角度固定连接
Function: Connect handrail and wall at flexible angle
- 安装方式: 墙上安装
Installation method: Wall mounting

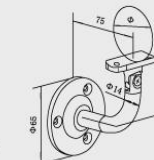

编号 Code	Φ
SK-3225-42	Φ42.4
SK-3225-51	Φ50.8



拉丝 SSS 镜光 PSS

JRS-8629 扶手托架 Handrail Bracket

产品属性 Product features

- 表面处理: 拉丝/镜光/PVD
Finish: Satin/Polish/PVD
- 主要材质: SUS304/SUS316不锈钢
Material: SUS304/SUS316 Stainless Steel
- 主要功能: 扶手与墙固定连接
Function: Connect handrail and wall
- 安装方式: 墙上安装
Installation method: Wall mounting

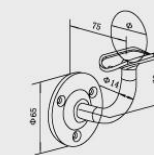

编号 Code	Φ
SK-3226-42	Φ42.4
SK-3226-51	Φ50.8

专业栏杆系统 PROFESSIONAL RAILING SYSTEM



拉丝 SSS 抛光 PSS

JRS-8630 活动扶手托架 Adjustable Handrail Bracket

产品属性 Product features

- 表面处理: 拉丝/抛光/PVD
Finish: Satin/Polish/PVD
- 主要材质: SUS304/SUS316不锈钢
Material: SUS304/SUS316 Stainless Steel
- 主要功能: 扶手与墙壁活角度固定连接
Function: Connect handrail and wall at flexible angle
- 安装方式: 墙上安装
Installation method: Wall mounting

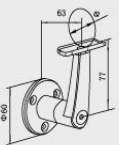

编号 Code	Φ
SK-3668-42	Φ42.4
SK-3668-51	Φ50.8



拉丝 SSS 抛光 PSS

JRS-8631 扶手托架 Handrail Bracket

产品属性 Product features

- 表面处理: 拉丝/抛光/PVD
Finish: Satin/Polish/PVD
- 主要材质: SUS304/SUS316不锈钢
Material: SUS304/SUS316 Stainless Steel
- 主要功能: 扶手与墙固定连接
Function: Connect handrail and wall
- 安装方式: 墙上安装
Installation method: Wall mounting

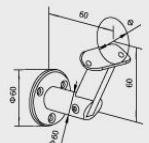

编号 Code	Φ
SK-3669-42	Φ42.4
SK-3669-51	Φ50.8



拉丝 SSS 抛光 PSS

JRS-8632 玻璃活动扶手托架 Adjustable Handrail Bracket For Glass

产品属性 Product features

- 表面处理: 拉丝/抛光/PVD
Finish: Satin/Polish/PVD
- 主要材质: SUS304/SUS316不锈钢
Material: SUS304/SUS316 Stainless Steel
- 主要功能: 扶手与双边玻璃活角度固定连接
Function: Connect handrail and double side glass at flexible angle.
- 安装方式: 安装在玻璃上
Installation method: Fixed on glass



编号 Code	Φ
SK-1613-42	Φ42.4
SK-1613-51	Φ50.8

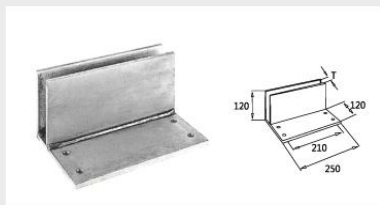
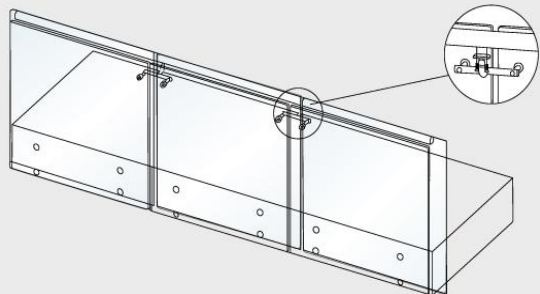

JRS-8633 玻璃托架 Glass bracket

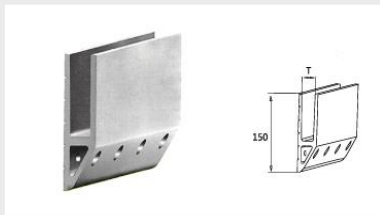

JRS-8634 玻璃托架 Glass bracket

金日盛®
HARDWARE PRODUCTS



金日盛玻璃扶手托架系统
JINRISHENG
Glass Handrail Bracket System



超薄玻璃扶手托架可以附加支持通过玻璃，这是一个极具吸引力的解决方法。快速安装，现代，时尚扶手系统。

The super slim support bracket can be attached to the support by means of the glass panel. It is an extremely attractive solution for the quick installation of modern, stylish handrail systems.



JRS-8635 玻璃扶手托架 Handrail Bracket For Glass

产品属性 Product features

- 表面处理: 拉丝/抛光/PVD
Finish: Satin/Polish/PVD
- 主要材质: SUS304/SUS316不锈钢
Material: SUS304/SUS316 Stainless Steel
- 主要功能: 扶手与玻璃固定连接
Function: Connect handrail and glass
- 安装方式: 安装在玻璃上
Installation method: Fixed on glass

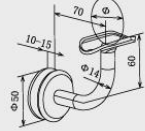

编号 Code	Φ
SK-1218-42	Φ42.4
SK-1218-51	Φ50.8



拉丝 SSS 抛光 PSS



JRS-8636

产品属性 Product features

- 表面处理: 拉丝/抛光/PVD
Finish: Satin/Polish/PVD
- 主要材质: SUS304/SUS316不锈钢
Material: SUS304/SUS316 Stainless Steel
- 主要功能: 圆管栏杆与玻璃固定连接, 可左右调整+/-3°
Function: Connect round tube baluster and glass, +/-3° adjustable for left and right
- 安装方式: 圆管栏杆上内六角螺丝拧紧安装
Installation method: Fixed on the round tube baluster by tightening the immer hesagon screws



JRS-8637

产品属性 Product features

- 表面处理: 拉丝/抛光/PVD
Finish: Satin/Polish/PVD
- 主要材质: SUS304/SUS316不锈钢
Material: SUS304/SUS316 Stainless Steel
- 主要功能: 圆管栏杆与玻璃固定连接, 可左右调整+/-3°
Function: Connect round tube baluster and glass, +/-3° adjustable for left and right
- 安装方式: 圆管栏杆上内六角螺丝拧紧安装
Installation method: Fixed on the round tube baluster by tightening the immer hesagon screws

JRS-8638

产品属性 Product features

- 表面处理: 拉丝/抛光/PVD
Finish: Satin/Polish/PVD
- 主要材质: SUS304/SUS316不锈钢
Material: SUS304/SUS316 Stainless Steel
- 主要功能: 圆管栏杆与玻璃固定连接, 可左右调整+/-3°
Function: Connect round tube baluster and glass, +/-3° adjustable for left and right
- 安装方式: 圆管栏杆上内六角螺丝拧紧安装
Installation method: Fixed on the round tube baluster by tightening the immer hesagon screws



拉丝 SSS 抛光 PSS

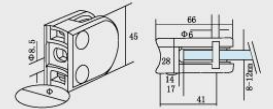

编号 Code	Φ
SK-1442-48	Φ48.3
SK-1442-51	Φ50.8

JRS-8639

产品属性 Product features

- 表面处理: 拉丝/抛光/PVD
Finish: Satin/Polish/PVD
- 主要材质: SUS304/SUS316不锈钢
Material: SUS304/SUS316 Stainless Steel
- 主要功能: 圆管栏杆与玻璃固定连接, 可左右调整+/-3°
Function: Connect round tube baluster and glass, +/-3° adjustable for left and right
- 安装方式: 圆管栏杆上内六角螺丝拧紧安装
Installation method: Fixed on the round tube baluster by tightening the immer hesagon screws



拉丝 SSS 抛光 PSS

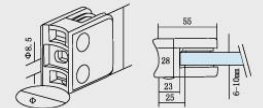

编号 Code	Φ
SK-1443-48	Φ48.3
SK-1443-51	Φ50.8

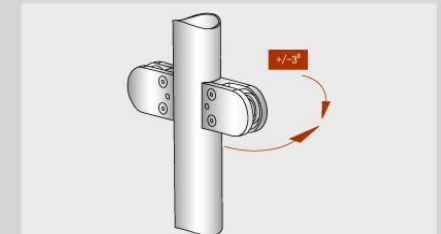
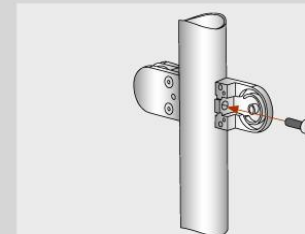

JRS-8629, JRS-8630与圆管栏杆固定时, 可以左右调整+/-3°, 方便调整玻璃垂直。
When fix JRS-8629, JRS-8630 with round tube baluster, it can be +/-3° adjustable for left and right to adjust the uprightness of glass

金日成®
HARDWARE PRODUCTS

STAINLESS HOUSE DECORATE
SERIES
不锈钢家装系列



表面处理: 砂光、镜光
Finish: satin, mirror light

主要材质: 不锈钢
Material: Stainless steel

主要功能: 玻璃与栏杆固定连接
Function: Connect glass and baluster

安装方式: 膨胀螺栓地面安装
Installation method: Floor mounting by the expansion bolt

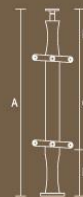

Size(mm)			
A	B	C	D
850	220	420	210

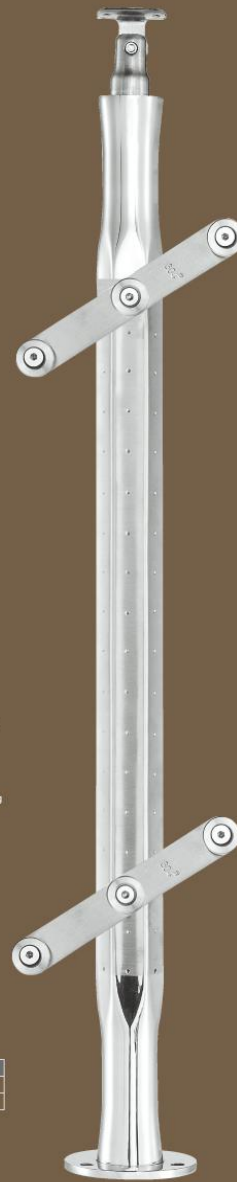

JRS-8040

表面处理: 砂光、镜光
Finish: satin, mirror light

主要材质: 不锈钢
Material: Stainless steel

主要功能: 玻璃与栏杆固定连接
Function: Connect glass and baluster

安装方式: 膨胀螺栓地面安装
Installation method: Floor mounting by the expansion bolt



Size(mm)			
A	B	C	D
850	220	420	210

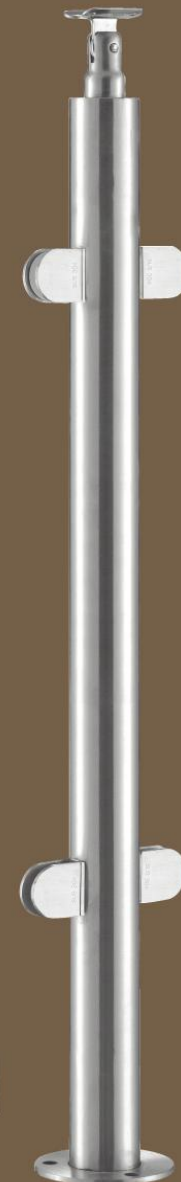

JRS-8041





表面处理: 砂光、镜光
Finish: satin, mirror light

主要材质: 不锈钢
Material: Stainless steel

主要功能: 玻璃与栏杆固定连接
Function: Connect glass and baluster

安装方式: 膨胀螺栓地面安装
Installation method: Floor mounting by the expansion bolt

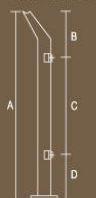

Size(mm)			
A	B	C	D
850	220	420	210

JRS-8042



表面处理: 砂光、镜光
Finish: satin, mirror light

主要材质: 不锈钢
Material: Stainless steel

主要功能: 玻璃与栏杆固定连接
Function: Connect glass and baluster

安装方式: 膨胀螺栓地面安装
Installation method: Floor mounting by the expansion bolt

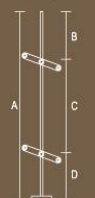

Size(mm)			
A	B	C	D
850	220	420	210

JRS-8043



表面处理: 砂光、镜光
Finish: satin, mirror light

主要材质: 不锈钢
Material: Stainless steel

主要功能: 玻璃与栏杆固定连接
Function: Connect glass and baluster

安装方式: 膨胀螺栓地面安装
Installation method: Floor mounting by the expansion bolt



Size(mm)			
A	B	C	D
850	220	420	210

JRS-8044

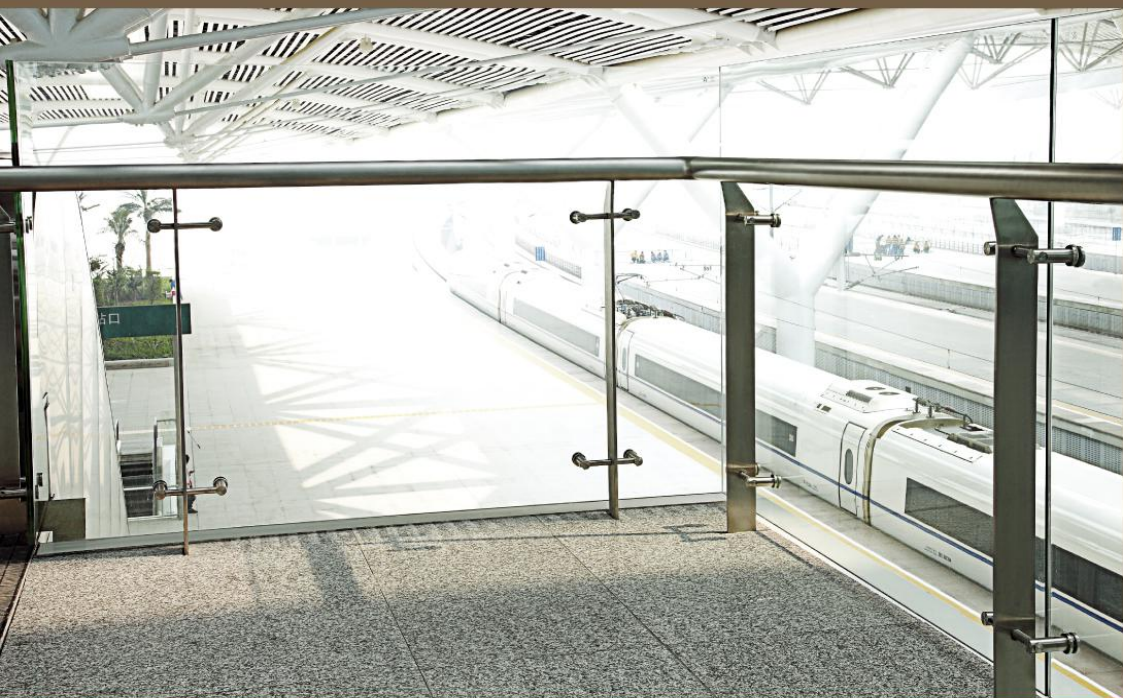

表面处理: 砂光、镜光
Finish: satin, mirror light

主要材质: 不锈钢
Material: Stainless steel

主要功能: 玻璃与栏杆固定连接
Function: Connect glass and baluster

安装方式: 膨胀螺栓地面安装
Installation method: Floor mounting by the expansion bolt

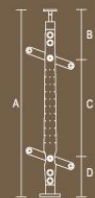

Size(mm)			
A	B	C	D
850	220	420	210

JRS-8045



表面处理: 砂光、镜光
Finish: satin, mirror light

主要材质: 不锈钢
Material: Stainless steel

主要功能: 玻璃与栏杆固定连接
Function: Connect glass and baluster

安装方式: 膨胀螺栓地面安装
Installation method: Floor mounting by the expansion bolt

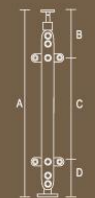

Size(mm)			
A	B	C	D
850	220	420	210

JRS-8046



表面处理: 砂光、镜光
Finish: satin, mirror light

主要材质: 不锈钢
Material: Stainless steel

主要功能: 玻璃与栏杆固定连接
Function: Connect glass and baluster

安装方式: 膨胀螺栓地面安装
Installation method: Floor mounting by the expansion bolt

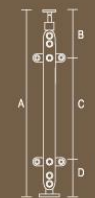

Size(mm)			
A	B	C	D
850	220	420	210

JRS-8047



JRS-8048

- 表面处理: 砂光、镜光
Finish: satin, mirror light
- 主要材质: 不锈钢
Material: Stainless steel
- 主要功能: 玻璃与栏杆固定连接
Function: Connect glass and baluster
- 安装方式: 膨胀螺栓地面安装
Installation method: Floor mounting by the expansion bolt

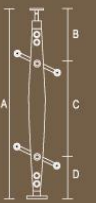

Size(mm)			
A	B	C	D
850	220	420	210



JRS-8049

- 表面处理: 砂光、镜光
Finish: satin, mirror light
- 主要材质: 不锈钢
Material: Stainless steel
- 主要功能: 玻璃与栏杆固定连接
Function: Connect glass and baluster
- 安装方式: 膨胀螺栓地面安装
Installation method: Floor mounting by the expansion bolt

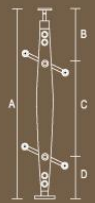

Size(mm)			
A	B	C	D
850	220	420	210

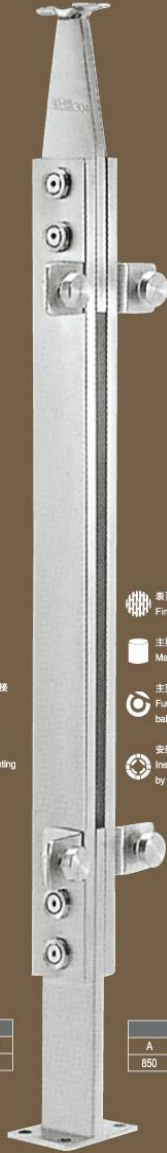

JRS-8050

- 表面处理: 砂光、镜光
Finish: satin, mirror light
- 主要材质: 不锈钢
Material: Stainless steel
- 主要功能: 玻璃与栏杆固定连接
Function: Connect glass and baluster
- 安装方式: 膨胀螺栓地面安装
Installation method: Floor mounting by the expansion bolt



Size(mm)			
A	B	C	D
850	220	420	210

- 表面处理: 砂光、镜光
Finish: satin, mirror light
- 主要材质: 不锈钢
Material: Stainless steel
- 主要功能: 玻璃与栏杆固定连接
Function: Connect glass and baluster
- 安装方式: 膨胀螺栓地面安装
Installation method: Floor mounting by the expansion bolt

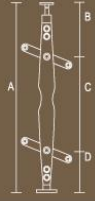

Size(mm)			
A	B	C	D
850	220	420	210



JRS-8051

- 表面处理: 砂光、镜光
Finish: satin, mirror light
- 主要材质: 不锈钢
Material: Stainless steel
- 主要功能: 玻璃与栏杆固定连接
Function: Connect glass and baluster
- 安装方式: 膨胀螺栓地面安装
Installation method: Floor mounting by the expansion bolt

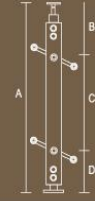

Size(mm)			
A	B	C	D
850	220	420	210



JRS-8052

- 表面处理: 砂光、镜光
Finish: satin, mirror light
- 主要材质: 不锈钢
Material: Stainless steel
- 主要功能: 玻璃与栏杆固定连接
Function: Connect glass and baluster
- 安装方式: 膨胀螺栓地面安装
Installation method: Floor mounting by the expansion bolt



Size(mm)			
A	B	C	D
850	220	420	210



JRS-8053





表面处理: 砂光、镜光
Finish: satin, mirror light

主要材质: 不锈钢
Material: Stainless steel

主要功能: 玻璃与栏杆固定连接
Function: Connect glass and baluster

安装方式: 膨胀螺栓地面安装
Installation method: Floor mounting by the expansion bolt



Size(mm)			
A	B	C	D
850	220	420	210

JRS-8054



表面处理: 砂光、镜光
Finish: satin, mirror light

主要材质: 不锈钢
Material: Stainless steel

主要功能: 玻璃与栏杆固定连接
Function: Connect glass and baluster

安装方式: 膨胀螺栓地面安装
Installation method: Floor mounting by the expansion bolt

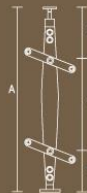

Size(mm)			
A	B	C	D
850	220	420	210

JRS-8055



表面处理: 砂光、镜光
Finish: satin, mirror light

主要材质: 不锈钢夹木
Material: stainless steel and wood

主要功能: 玻璃与栏杆固定连接
Function: Connect glass and baluster

安装方式: 膨胀螺栓地面安装
Installation method: Floor mounting by the expansion bolt

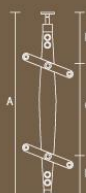

Size(mm)			
A	B	C	D
850	220	420	210

JRS-8056

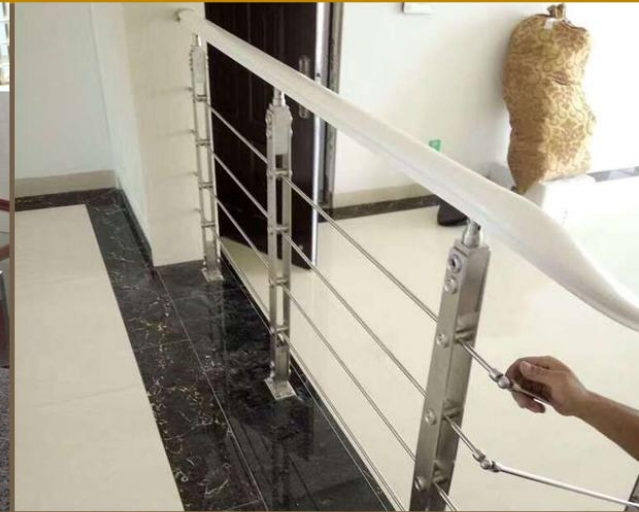

表面处理: 砂光、镜光
Finish: satin, mirror light

主要材质: 不锈钢
Material: Stainless steel

主要功能: 穿拉丝
Function: Through drawing

安装方式: 膨胀螺栓地面安装
Installation method: Floor mounting by the expansion bolt



Size(mm)			
A	B	C	D
850	220	420	210

JRS-8057

表面处理: 砂光、镜光
Finish: satin, mirror light

主要材质: 不锈钢
Material: Stainless steel

主要功能: 穿拉丝
Function: Through drawing

安装方式: 膨胀螺栓地面安装
Installation method: Floor mounting by the expansion bolt



Size(mm)			
A	B	C	D
850	220	420	210

JRS-8058



表面处理: 砂光、镜光
Finish: satin, mirror light

主要材质: 不锈钢
Material: Stainless steel

主要功能: 穿拉丝
Function: Through drawing

安装方式: 膨胀螺栓地面安装
Installation method: Floor mounting by the expansion bolt



Size(mm)			
A	B	C	D
850	220	420	210

JRS-8059



Model:[A4]



Model:[A3]



Model:[A2]



Model:[A1]



- 表面处理: 砂光、镜光
Finish: satin, mirror light
- 主要材质: 不锈钢
Material: Stainless steel
- 主要功能: 玻璃与栏杆固定连接
Function: Connect glass and baluster
- 安装方式: 膨胀螺丝地面安装
Installation method: Floor mounting by the expansion bolt



Size(mm)			
A	B	C	D
850	220	420	210

JRS-8060



- 表面处理: 砂光、镜光
Finish: satin, mirror light
- 主要材质: 不锈钢
Material: Stainless steel
- 主要功能: 穿拉丝
Function: Through drawing
- 安装方式: 膨胀螺丝地面安装
Installation method: Floor mounting by the expansion bolt



Size(mm)			
A	B	C	D
850	220	420	210

JRS-8061



- 表面处理: 砂光、镜光
Finish: satin, mirror light
- 主要材质: 不锈钢
Material: Stainless steel
- 主要功能: 玻璃与栏杆固定连接
Function: Connect glass and baluster
- 安装方式: 膨胀螺丝地面安装
Installation method: Floor mounting by the expansion bolt

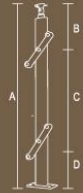

Size(mm)			
A	B	C	D
850	220	420	210

JRS-8062



- 表面处理: 砂光、镜光
Finish: satin, mirror light
- 主要材质: 不锈钢
Material: Stainless steel
- 主要功能: 穿拉丝
Function: Through drawing
- 安装方式: 膨胀螺丝地面安装
Installation method: Floor mounting by the expansion bolt



Size(mm)			
A	B	C	D
850	220	420	210

JRS-8063



- 表面处理: 砂光、镜光
Finish: satin, mirror light
- 主要材质: 不锈钢
Material: Stainless steel
- 主要功能: 玻璃与栏杆固定连接
Function: Connect glass and baluster
- 安装方式: 膨胀螺丝地面安装
Installation method: Floor mounting by the expansion bolt



Size(mm)			
A	B	C	D
850	220	420	210

JRS-8064

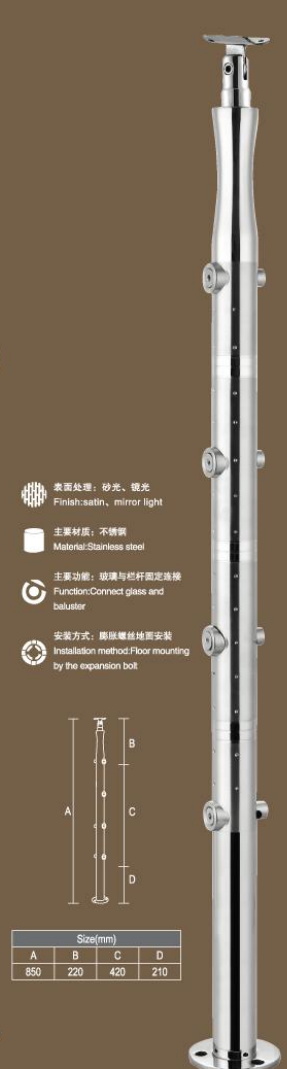

- 表面处理: 砂光、镜光
Finish: satin, mirror light
- 主要材质: 不锈钢
Material: Stainless steel
- 主要功能: 玻璃与栏杆固定连接
Function: Connect glass and baluster
- 安装方式: 膨胀螺丝地面安装
Installation method: Floor mounting by the expansion bolt



Size(mm)			
A	B	C	D
850	220	420	210

JRS-8065



表面处理: 砂光、镜光
Finish: satin, mirror light

主要材质: 不锈钢+木
Material: Stainless steel and wood

主要功能: 玻璃与栏杆固定连接
Function: Connect glass and baluster

安装方式: 膨胀螺丝地面安装
Installation method: Floor mounting by the expansion bolt



Size(mm)			
A	B	C	D
850			

JRS-8066



表面处理: 砂光、镜光
Finish: satin, mirror light

主要材质: 不锈钢
Material: Stainless steel

主要功能: 穿拉丝
Function: Through drawing

安装方式: 膨胀螺丝地面安装
Installation method: Floor mounting by the expansion bolt



Size(mm)			
A	B	C	D
850	220	420	210

JRS-8067



表面处理: 砂光、镜光
Finish: satin, mirror light

主要材质: 不锈钢+木
Material: stainless steel and wood

主要功能: 穿拉丝
Function: Through drawing

安装方式: 膨胀螺丝地面安装
Installation method: Floor mounting by the expansion bolt



Size(mm)			
A	B	C	D
850	220	420	210

JRS-8068



Glass Bracket



Fastener



Aluminum U Channel



Stainless Steel Slot Tube



JRS-S1



JRS-S2



JRS-S3

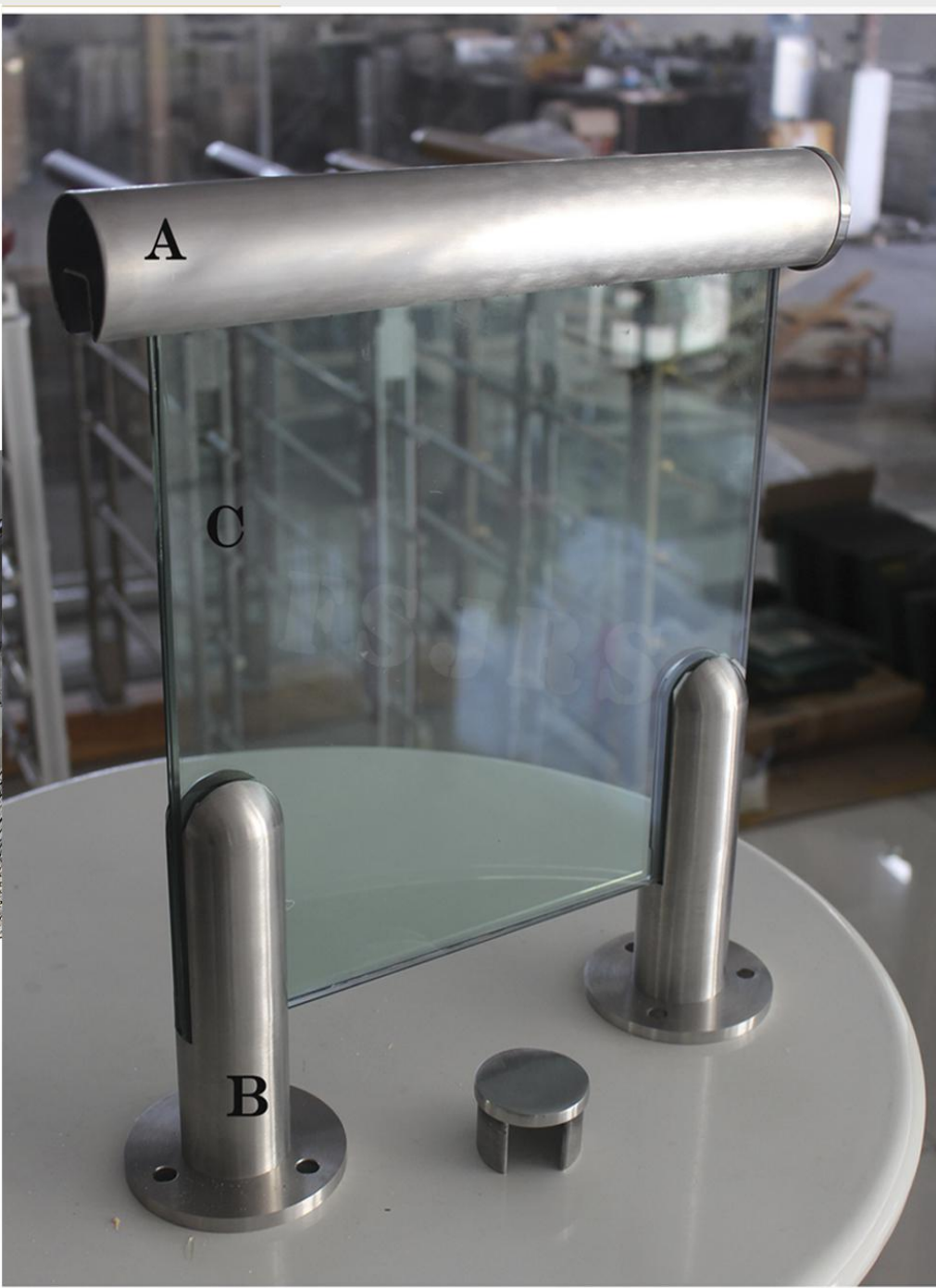

A: $\phi 50.8$ Slot Pipe



B: SUS Spigot



C: Laminated Glass





JRS-8156

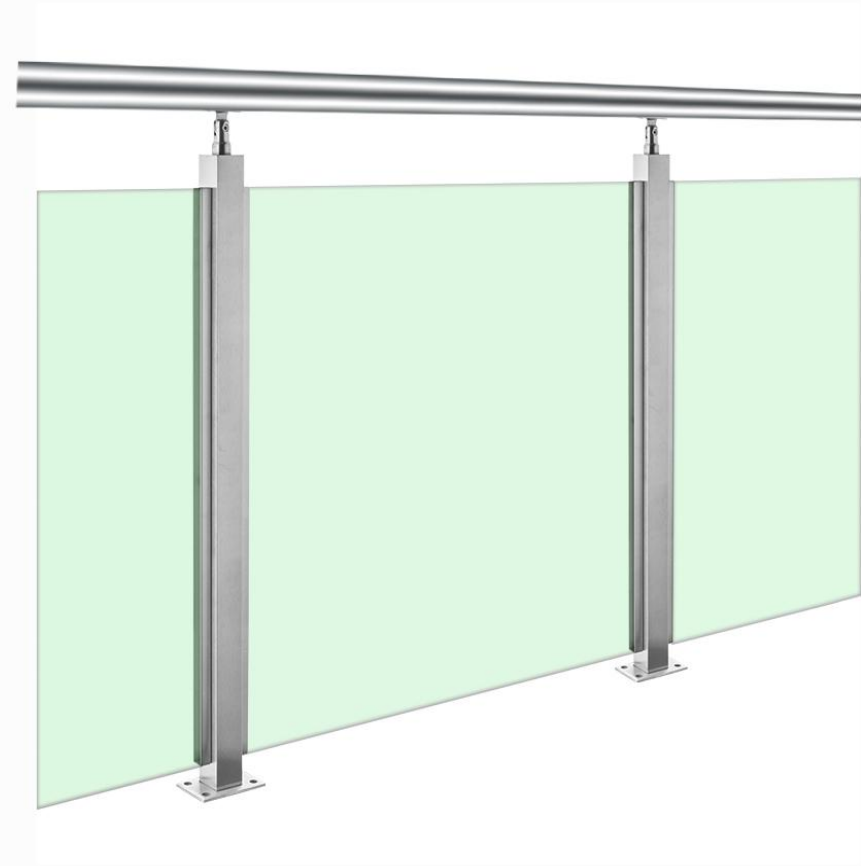

JRS-8157

