

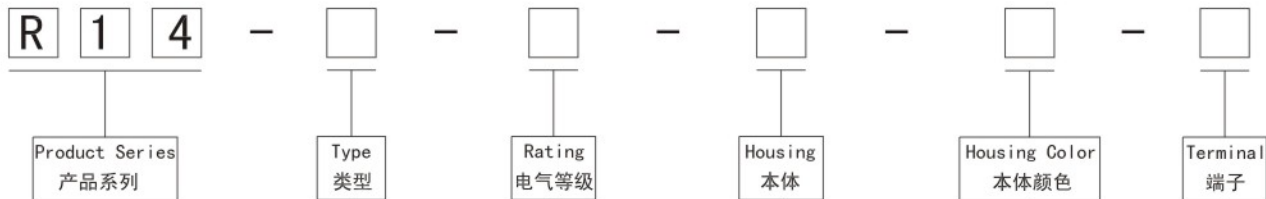

Rated current、voltage 额定电流、电压	10A 250VAC 15A 250VAC
Insulation resistance 绝缘电阻	100MΩ Min
Dielectric strength 介电强度	1,500 VAC/1Min



A	Single Socket 单一插座
B	Switch And Socket 开关+插座
C	Insurance Tube And Socket 保险管+插座
D	Insurance Tube And Switch And Socket 保险管+开关+插座

1	10A 250VAC
2	15A 250VAC

A		F	
B		G	
C		H	
D		J	
E		K	

B	Black 黑色
W	White 白色
G	Grey 灰色

1	
2	
3	
4	
5	
6	



R14-A-1AB4

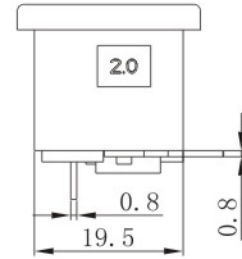
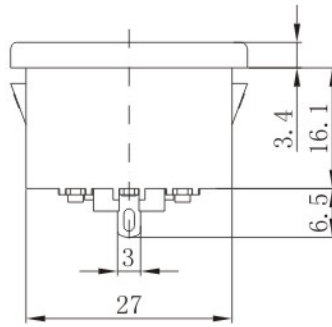

Panel Hole Size
面板开孔尺寸

(For Reference)

Panel Thick: 0.8, 1.0, 1.2, 1.5, 2.0
板厚: 0.8, 1.0, 1.2, 1.5, 2.0

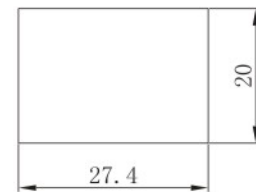
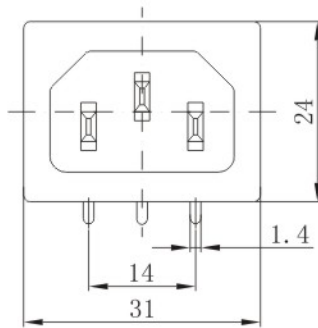

R14-A-1BB1

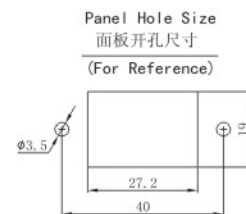
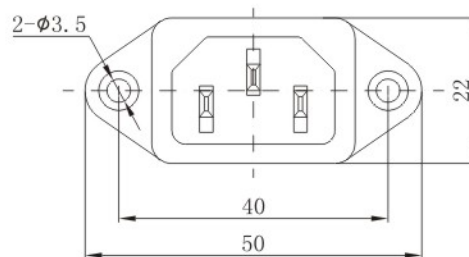
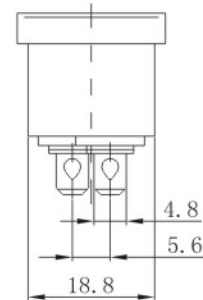
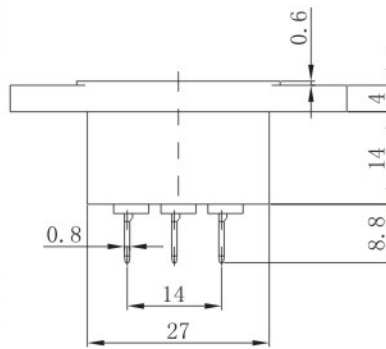



R14-A-1CB1

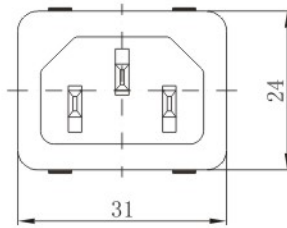
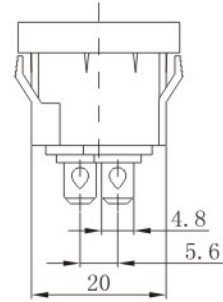
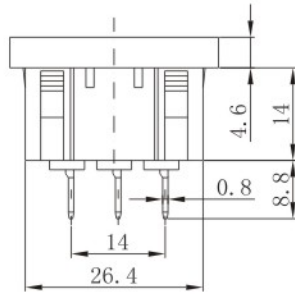

Panel Hole Size
面板开孔尺寸
(For Reference)

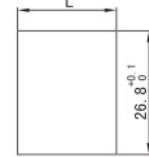

L	Panel Thickness 面板厚度
21.0~21.4	0.75-1.25
21.4~21.8	1.25-2.00
21.8~22.0	2.00-3.00



R14-A-1DB1

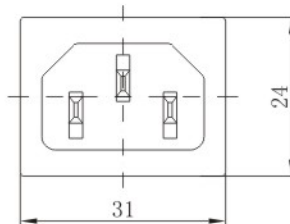
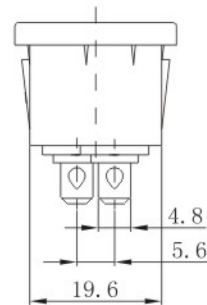
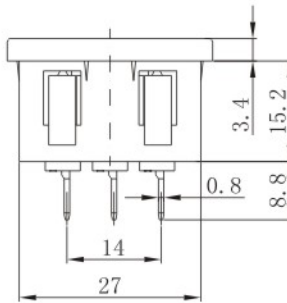

Panel Hole Size
面板开孔尺寸
(For Reference)
Panel Thick: 0.8, 1.0, 1.2, 1.5, 2.0
板厚: 0.8, 1.0, 1.2, 1.5, 2.0

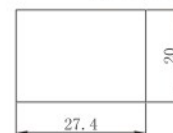



R14-B-1EB1

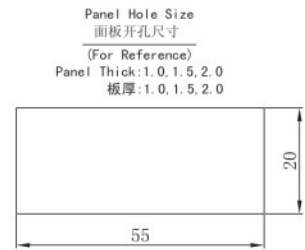
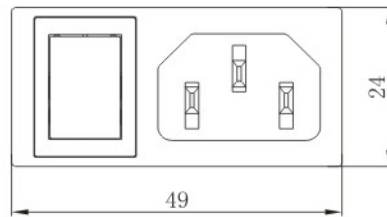
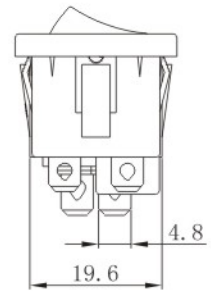
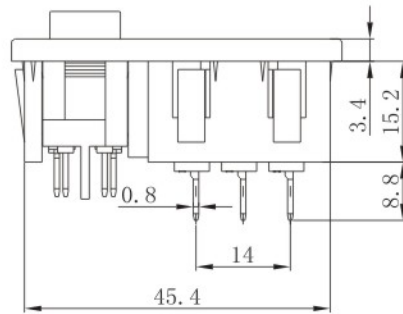

R14-B-1FB2

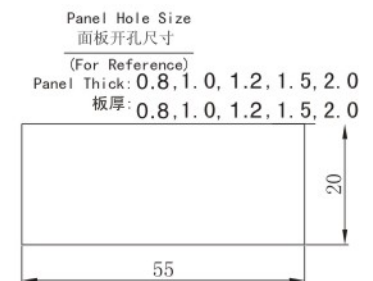
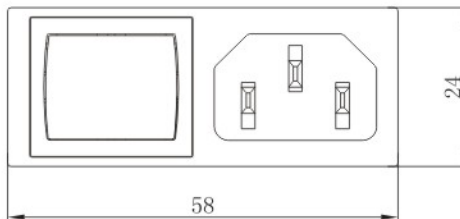
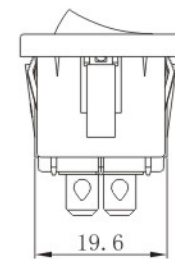
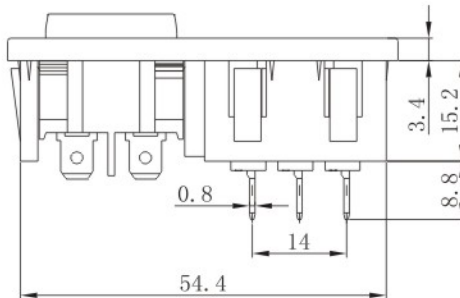



R14-C-1GB1

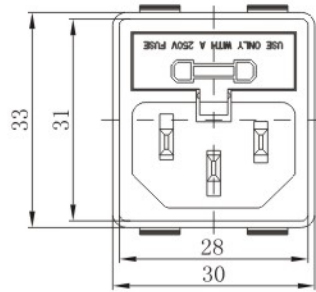
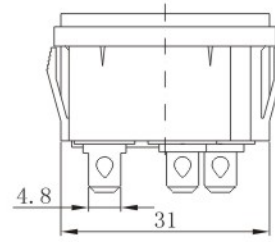
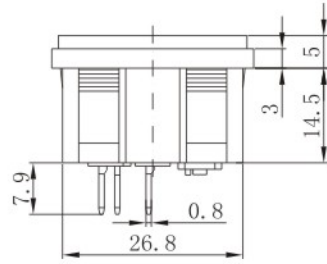

Panel Hole Size
面板开孔尺寸
(For Reference)

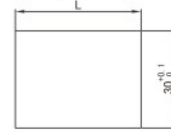

L	Panel Thickness 面板厚度
34.0~34.2	0.75-1.25
34.2~34.4	1.25-2.00
34.4~34.6	2.00-3.00



R14-C-1HB1

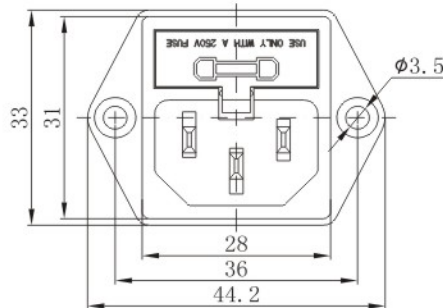
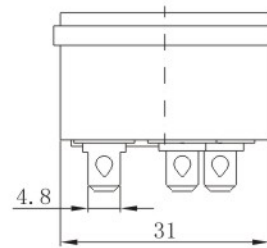
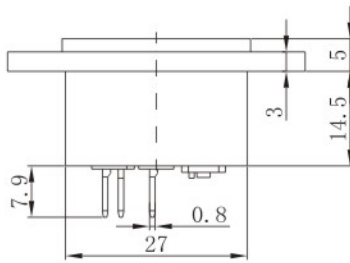

Panel Hole Size
面板开孔尺寸
(For Reference)

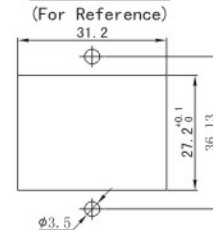



R14-D-1JC1

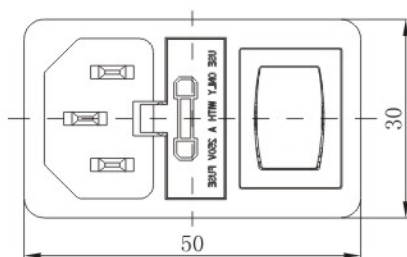
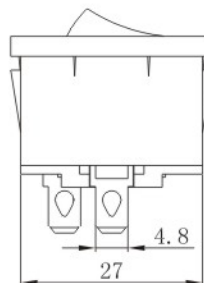
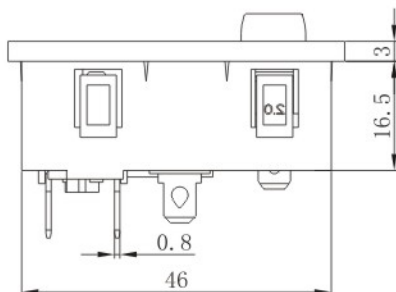

Panel Hole Size
面板开孔尺寸
(For Reference)
Panel Thick: 0.8, 1.0, 1.2, 1.5, 2.0
板厚: 0.8, 1.0, 1.2, 1.5, 2.0

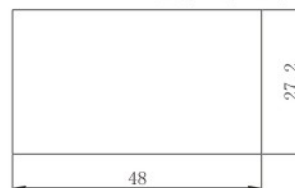

R14-D-1KB1

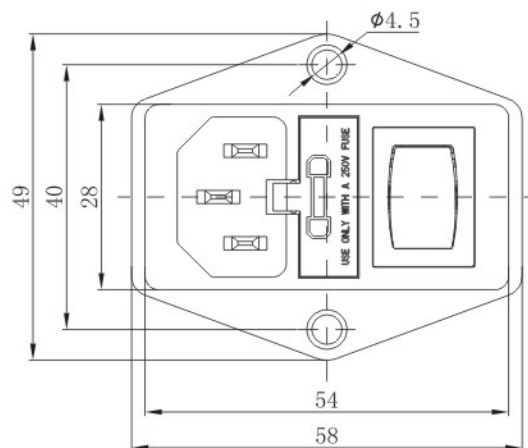
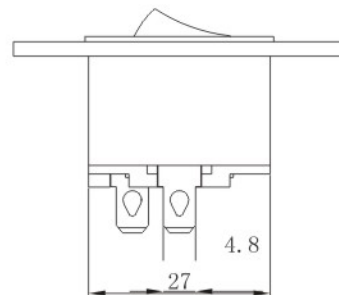
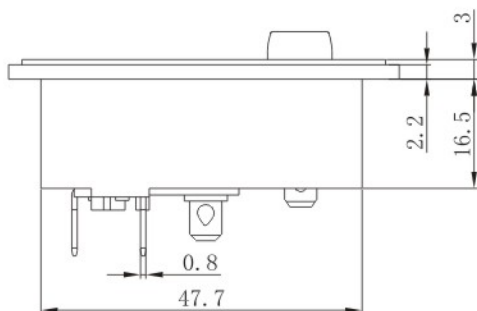

Panel Hole Size
面板开孔尺寸
(For Reference)

